



HIRSCHMANN

A **BELDEN** BRAND

User Manual

Installation Industrial Ethernet Ruggedized Switch MACH1000 Family

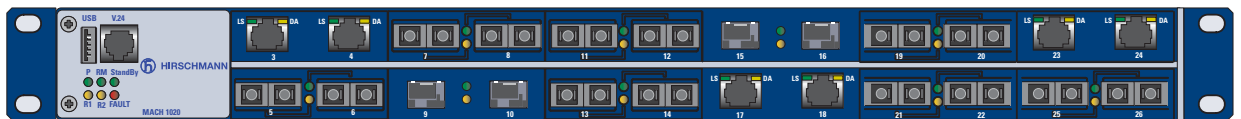

MACH1020

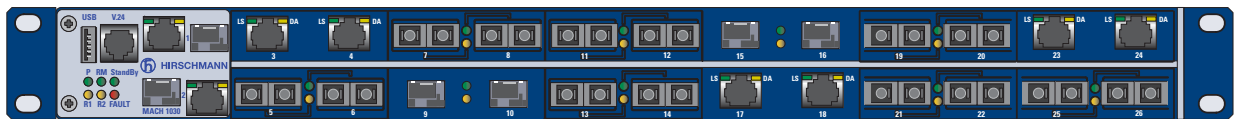

MACH1030

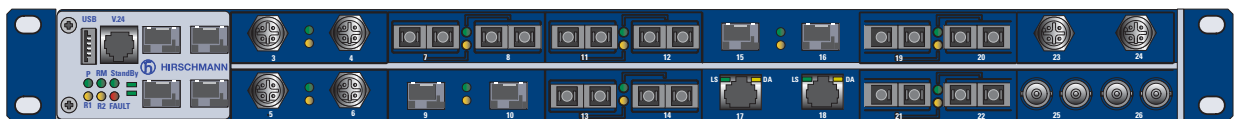

MACH1032

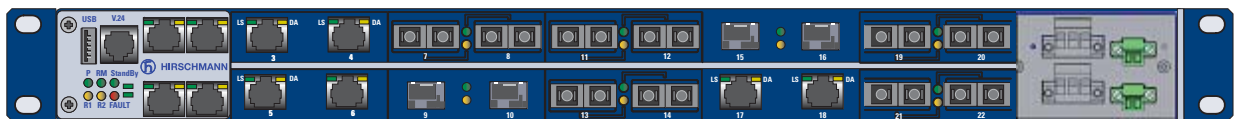

MACH1132

The naming of copyrighted trademarks in this manual, even when not specially indicated, should not be taken to mean that these names may be considered as free in the sense of the trademark and tradename protection law and hence that they may be freely used by anyone.

© 2023 Hirschmann Automation and Control GmbH

Manuals and software are protected by copyright. All rights reserved. The copying, reproduction, translation, conversion into any electronic medium or machine scannable form is not permitted, either in whole or in part. An exception is the preparation of a backup copy of the software for your own use.

The performance features described here are binding only if they have been expressly agreed when the contract was made. This document was produced by Hirschmann Automation and Control GmbH according to the best of the company's knowledge. Hirschmann reserves the right to change the contents of this document without prior notice. Hirschmann can give no guarantee in respect of the correctness or accuracy of the information in this document.

Hirschmann can accept no responsibility for damages, resulting from the use of the network components or the associated operating software. In addition, we refer to the conditions of use specified in the license contract.

You can get the latest version of this manual on the Internet at:
<https://www.doc.hirschmann.com>

Hirschmann Automation and Control GmbH
Stuttgarter Str. 45-51
72654 Neckartenzlingen
Germany

Contents

Safety instructions	5
About this Manual	15
Key	16
1 Description	17
1.1 General device description	17
1.2 Combination options	18
1.3 Description of the device variants	20
1.3.1 Port assignment	21
1.3.2 Front view MACH1000 with 2 × Gigabit ports	22
1.3.3 Front view MACH1000 with 4 × Gigabit ports (SFP)	23
1.3.4 Front view MACH1000 with 4 Gigabit ports (2 × SFP and 2 × RJ45)	24
1.3.5 Front view MACH1000 with PoE	25
1.3.6 Views MACH1000, ports on the back	26
1.3.7 Connections for voltage-carrying lines	27
1.3.8 Support of PoE	29
1.4 Ethernet ports	29
1.4.1 10/100/1000 Mbit/s twisted pair port	29
1.4.2 10/100 Mbit/s twisted pair port	30
1.4.3 1000 Mbit/s F/O port	30
1.4.4 100 Mbit/s F/O port	31
1.4.5 10 Mbit/s F/O port	31
1.4.6 Pin assignments	31
1.5 Display elements	32
1.5.1 Device status	33
1.5.2 Port status	34
1.6 Management interfaces	35
1.6.1 V.24 interface (external management)	35
1.6.2 USB interface	35
1.7 Signal contact	36
2 Installation	37

2.1	Checking the package contents	37
2.2	Installing an SFP transceiver (optional)	38
2.3	Wiring of the terminal blocks for supply voltage and signal contact	38
2.3.1	Connecting the voltage supply terminals (power supply units “C” and “G”)	38
2.3.2	Connecting the plugged voltage supply (power supply units “L” and “M”)	41
2.3.3	Wiring the signal contact	43
2.4	Installing and grounding the device	44
2.4.1	Mounting in a switch cabinet	44
2.4.2	Vertical mounting on the wall	46
2.4.3	Grounding the device	46
2.5	Operating the device	47
2.6	Connecting data cables	47
2.6.1	Twisted Pair ports	47
2.6.2	Optical fiber ports	47
3	Making basic settings	48
3.1	First login (Password change)	49
4	Monitoring the ambient air temperature	50
5	Maintenance and service	51
6	Disassembly	52
6.1	Removing the device	52
6.2	Removing an SFP transceiver (optional)	52
7	Technical data	53
A	Further support	66

Safety instructions

WARNING

UNCONTROLLED MACHINE ACTIONS

To avoid uncontrolled machine actions caused by data loss, configure all the data transmission devices individually.

Before you start any machine which is controlled via data transmission, be sure to complete the configuration of all data transmission devices.

Failure to follow these instructions can result in death, serious injury, or equipment damage.

■ **General safety instructions**

You operate this device with electricity. Improper usage of the device entails the risk of physical injury or significant property damage. The proper and safe operation of this device depends on proper handling during transportation, proper storage and installation, and careful operation and maintenance procedures.

- Before connecting any cable, read this document, and the safety instructions and warnings.
- Operate the device with undamaged components exclusively.
- The device is free of any service components. In case of a damaged or malfunctioning device, turn off the supply voltage and return the device to Hirschmann for inspection.

■ **Certified usage**

- Use the product only for the application cases described in the Hirschmann product information, including this manual.
- Operate the product only according to the technical specifications. [See “Technical data” on page 53.](#)
- Connect to the product only components suitable for the requirements of the specific application case.

■ **Installation site requirements**

- Install this device only in a switch cabinet or in an operating site with restricted access, to which maintenance staff have exclusive access.
- Mount the device horizontally in a cabinet or vertically on a flat surface. Operating the device as a table unit is inadmissible. [See “General technical data” on page 53.](#)
- Install the device in a fire protected shell if you are mounting it vertically.

- If you are operating the device in a 19" switch cabinet: install sliding/mounting rails for supporting the weight of the device.
- When you are selecting the installation location, make sure you observe the climatic threshold values specified in the technical data.
- Use the device in an environment with a maximum pollution degree that complies with the specifications in the technical data.

■ **Strain relief**

Note: If the strain relief is insufficient, there is a potential risk of torsion, contact problems and creeping interruptions.

- Relieve the connection points of cables and lines from mechanical stress.
- Design strain reliefs in such a way that they help prevent any mechanical damage to cables, wires or conductors caused by external influences or their own weight.
- To help prevent damage to device connections, connectors and cables, follow the instructions for proper installation in accordance with DIN VDE 0100-520:2013-06, sections 522.6, 522.7 and 522.13.

■ **Device casing**

Only technicians authorized by the manufacturer are permitted to open the casing.

- Make sure there is at least 10 cm (3.94 in) of space in front of the ventilation slits of the casing.
[See "General technical data" on page 53.](#)
- Never insert pointed objects (narrow screwdrivers, wires, etc.) into the device or into the connection terminals for electric conductors. Do not touch the connection terminals.
- Do not touch the housing during operation or shortly after switching off the device. Hot surfaces can cause injury.
- Operating the device in the maximum surrounding air temperature and stacking devices: When installing the device, make sure there is at least 1 free rack space (approx. 5 cm) above the device, because heat is discharged via the housing of the device.

■ **Qualification requirements for personnel**

- Only allow qualified personnel to work on the device.

Qualified personnel have the following characteristics:

- ▶ Qualified personnel are properly trained. Training as well as practical knowledge and experience make up their qualifications. This is the prerequisite for grounding and labeling circuits, devices, and systems in accordance with current standards in safety technology.
- ▶ Qualified personnel are aware of the dangers that exist in their work.

- ▶ Qualified personnel are familiar with appropriate measures against these hazards in order to reduce the risk for themselves and others.
- ▶ Qualified personnel receive training on a regular basis.

■ **National and international safety regulations**

- Verify that the electrical installation meets local or nationally applicable safety regulations.

■ **Grounding the device**

The device is grounded via the separate grounding screw on the back of the device.

- Use a wire cross section for the ground conductor that is no smaller than the cross section of the supply voltage connection, however of at least 1 mm² (AWG16).
- Ground the device before connecting any other cables.
- Disconnect the grounding only after disconnecting all other cables.

■ **Shielded ground**

The shielded ground wire of the twisted pairs cables is connected to the front panel as a conductor.

Beware of possible short circuits when connecting a cable section with conductive shield braiding.

■ **Supply voltage**

The supply voltage is electrically isolated from the casing.

Exclusively connect a supply voltage that corresponds to the type plate of your device.

- Every** time you connect the electrical conductors, make sure that the following requirements are met:
 - ▶ The power supply conforms to overvoltage category I or II.
 - ▶ The power supply has an easily accessible disconnecting device (for example a switch or a plug). This disconnecting device is clearly identified. So in the case of an emergency, it is clear which disconnecting device belongs to which power supply cable.
 - ▶ The electrical wires are voltage-free.
 - ▶ The ground screw on the back of the device is connected to the protective conductor.
 - ▶ There is a fuse in the outer conductor (AC) or the positive conductor (DC) of the voltage supply.
Regarding the properties of this fuse: [See “General technical data” on page 53.](#)
 - ▶ Supply with DC voltage: the fuse is suitable for a DC voltage.
 - ▶ If the neutral conductor (AC) or the negative conductor (DC) is not grounded: there is a fuse in each of the two wires.
 - ▶ The wire cross section of the power supply cable is at least 1 mm² (North America: AWG16) on the supply voltage input.

- ▶ The cross-section of the protective conductor is the same size as or bigger than the cross-section of the power supply cables.
 - ▶ The cables used are permitted for the temperature range of the application case.
 - ▶ Relevant for North America:
For use in Class 2 circuits, the copper wire conforms to class 1, 140/167 °F or 167 °F (60/75 °C or 75 °C).
- Start connecting the electrical wires only if **all** the above safety requirements are fulfilled.
 - Verify that the electrical installation meets locally or nationally applicable safety regulations.
 - Use undamaged parts.
 - Internal fuses are triggered only in the case of a detected error in the device. In case of damage or malfunction of the device, turn off the supply voltage and return the device to the plant for inspection.
 - Only switch on the device when the casing is closed.
 - First connect the ground screw on the back of the device with the protective conductor before you set up the other connections. When removing the connections, you remove the protective conductor last.
 - For supply voltage connections with protective conductor connection: First connect the protective conductor before connecting the wires for the supply voltage.
If your device comprises a 2nd supply voltage connection of this type: First connect the protective conductor before connecting the wires for the supply voltages.

■ Use in Hazardous Locations

Relevant for use in explosion hazard areas of the Hazardous Locations category (Class I, Division 2):

This device is only suitable for use in explosion hazard areas of category “Class I, Division 2, Groups A, B, C, D” or for use in non-explosion hazard areas.

The maximum operating temperature (ambient air) is 70 °C for device variants with the designation: MAR1xxx-xxxxxxxxxxxxxxxxxxxxxxxxxxxxxxxxUxxxxx or MAR1xxxxxxxxxxxxxxxxxxxxxxxxxxxxxxxxFxxxxx, where x corresponds to the letters and numbers from the table of product designations (see page 27 “Combination options”). The maximum operating temperature (ambient air) is 60 °C for device variants with the designation: MAR1xxx-xxxxxxxxxxxxxxxxxxxxxxxxxxxxxxxxSxxxxx, where x corresponds to the letters and numbers from the table of product designations (see page 27 “Combination options”).

For operation in explosion hazard areas of the Hazardous Locations category (Class I, Division 2), the following applies:



CLASS I; DIV. 2, GROUPS A, B, C, D
TEMPERATURE CODE T4
ENVIRONMENT:

Standard: 0 °C ... +60 °C

Extended: -40 °C ... +70 °C

List of standards: ISA 12.12.01, CSA C22.2 no. 213-M1987



Warning: When the USB port is being used, the device must be located in a housing that is locked by means of a tool.

Only disconnect devices when the system is voltage-free or is located in an area without inflammable concentrations or substances.

Avertissement - Risque d'explosion - Ne pas débrancher tant que le circuit est sous tension à moins que l'emplacement soit connu pour ne contenir aucune concentration de gaz inflammable.

Avertissement - Risque d'explosion - La substitution de tout composant peut rendre ce matériel incompatible pour une utilisation en classe I, division 2.

Class I, Division 2, Groups A, B, C, D
HAZARDOUS LOCATION ↔ **NON HAZARDOUS LOCATION**

Detail: left side

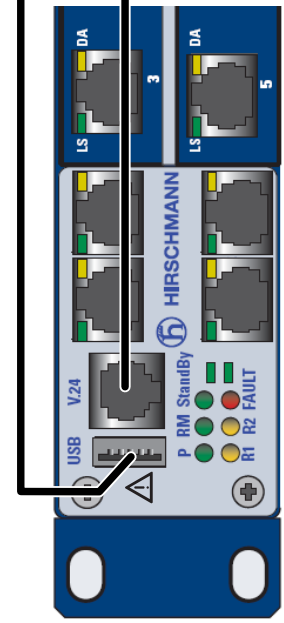

USB Port for Auto Configuration Adapter.
 For maintenance only.

V.24 Interface (External management)

Power Supply 2

9: Not present
 C: 18 V DC to 60 V DC
 G: 77 V DC to 300 V DC / 90 V AC to 265 V AC
 L: 18 V DC to 60 V DC
 M: 77 V DC to 300 V DC / 90 V AC to 265 V AC

Relay Contacts:
 Associated Apparatus:
 Equipment with nonincendive field wiring



Power Supply 1

C: 18 V DC to 60 V DC
 G: 77 V DC to 300 V DC / 90 V AC to 265 V AC
 L: 18 V DC to 60 V DC
 M: 77 V DC to 300 V DC / 90 V AC to 265 V AC

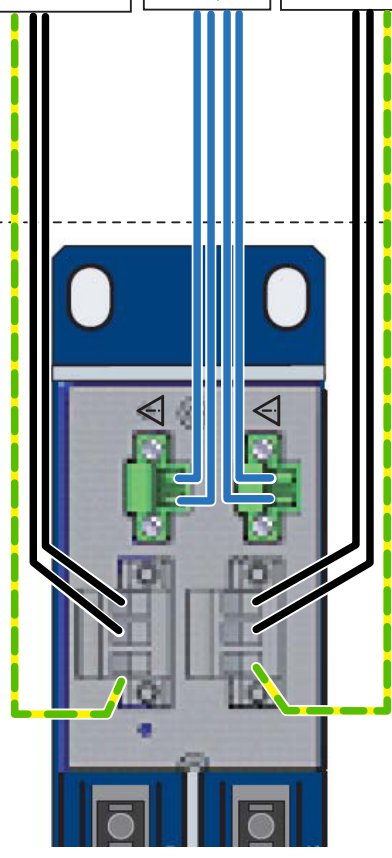

Detail: right side

The Use in Hazardous Locations is only allowed for MACH1000-Family model No's which are individually labeled "FOR USE IN CLASS I, DIVISION 2 HAZARDOUS LOCATIONS".

CONTROL DRAWING for Ethernet Switch MACH1000	
Family	
According to ANSI / ISA 12.12.01-2011	
Rev.: 0	Date: 2012-01-10
Document No.: 000159391DNR	

HIRSCHMANN
 A BELDEN BRAND

Page 1 of 2

Notes:



The nonincendive field wiring circuit concept allows interconnection of nonincendive field wiring apparatus and associated nonincendive field wiring apparatus using any of the wiring methods permitted for unclassified locations when certain parametric conditions are met.

Voltage: $V_{max} \geq V_{oc}$

Capacity: $C_a \geq C_i + C_{Cable}$

The maximum cable length has to be determined as follows:

(a) max. Cable Length $< (L_a - L_i) / L_{Cable}$ and (b) max. Cable Length $< (C_a - C_i) / C_{Cable}$

The lower value of (a) and (b) is to apply.

L_{Cable} : inductance per unit length of used cable.

C_{Cable} : capacitance per unit length of used cable.

Other C-parameters and L-parameters are according to ANSI / ISA 12.12.01-2011 section 7.

Where the cable capacitance and inductance per foot are not known, the following values shall be used:

C_{Cable} 60 pF/foot, L_{Cable} 0.2 μ H/foot

Nonincendive field wiring circuits must be wired in accordance with the National Electrical Code (NEC), NFPA 70, article 501.

Current: $I_{max} \geq I_{sc}$

Inductivity: $L_a \geq L_i + L_{Cable}$

Nonincendive Field Wiring Parameters:

The Relay Contacts are dependent upon the following Entity parameters:

V_{max}	I_{max}	C_i	L_i
30 V	90 mA	50 pF	2 μ H



WARNING – EXPLOSION HAZARD – SUBSTITUTION OF ANY COMPONENTS MAY IMPAIR SUITABILITY FOR HAZARDOUS LOCATIONS OR EXPLOSIVE ATMOSPHERES.

WARNING – EXPLOSION HAZARD – DO NOT DISCONNECT EQUIPMENT UNLESS POWER HAS BEEN SWITCHED OFF OR THE AREA IS KNOWN TO BE NON-HAZARDOUS.

DO NOT OPEN WHEN ENERGIZED.

CONTROL DRAWING for Ethernet Switch MACH1000

Family

According to ANSI / ISA 12.12.01-2011



Rev.: 0

Date: 2012-01-10

Document No.: 000159391DNR

Page 2 of 2

■ **CE marking**

The labeled devices comply with the regulations contained in the following European directive(s):

2011/65/EU and 2015/863/EU (RoHS)

Directive of the European Parliament and of the Council on the restriction of the use of certain hazardous substances in electrical and electronic equipment.

2014/30/EU (EMC)

Directive of the European Parliament and of the Council on the harmonisation of the laws of the Member States relating to electromagnetic compatibility.

2014/35/EU

Directive of the European Parliament and of the Council on the harmonisation of the laws of the Member States relating to the making available on the market of electrical equipment designed for use within certain voltage limits.

In accordance with the above-named EU directive(s), the EU conformity declaration will be at the disposal of the relevant authorities at the following address:

Hirschmann Automation and Control GmbH
Stuttgarter Str. 45-51
72654 Neckartenzlingen
Germany

You find the EU conformity declaration as PDF file for downloading on the Internet at: <https://www.doc.hirschmann.com/certificates.html>

The product can be used in the industrial sector.

- ▶ Interference immunity: EN 61000-6-2
- ▶ Emitted interference: EN 55032
- ▶ Safety: EN 62368-1

You find more information on technical standards here:

[“Technical data” on page 53](#)

The assembly guidelines provided in these instructions must be strictly adhered to in order to observe the EMC threshold values.

Warning! This is a class A device. This device can cause interference in living areas, and in this case the operator may be required to take appropriate measures.

■ **UKCA marking**

The labeled devices comply with the following UK regulations:

- **S.I. 2012 No. 3032**
Restriction of the Use of Certain Hazardous Substances in Electrical and Electronical Equipment Regulations
- **S.I. 2016 No. 1091**
Electromagnetic Compatibility Regulations



The UKCA conformity declaration will be available to the relevant authorities at the following address:

Belden UK Ltd.
1 The Technology Centre, Station Road
Framlingham, IP13 9EZ, United Kingdom

You find the UKCA conformity declaration as PDF file for downloading on the Internet at: <https://www.doc.hirschmann.com/certificates.html>

The product can be used in the industrial sector.

- ▶ Interference immunity: EN 61000-6-2
- ▶ Emitted interference: EN 55032
- ▶ Safety: EN 62368-1

Warning! This is a class A device. This device can cause interference in living areas, and in this case the operator may be required to take appropriate measures.

Note: The assembly guidelines provided in these instructions must be strictly adhered to in order to observe the EMC threshold values.

■ **LED or laser components**

LED or LASER components according to IEC 60825-1 (2014):
CLASS 1 LASER PRODUCT
CLASS 1 LED PRODUCT

■ **FCC note**

Supplier's Declaration of Conformity
47 CFR § 2.1077 Compliance Information

MACH1000

U.S. Contact Information

Belden – St. Louis
1 N. Brentwood Blvd. 15th Floor
St. Louis, Missouri 63105, United States
Phone: 314.854.8000

This device complies with part 15 of the FCC Rules. Operation is subject to the following two conditions: (1) This device may not cause harmful interference, and (2) this device must accept any interference received, including interference that may cause undesired operation.

Note: This equipment has been tested and found to comply with the limits for a Class A digital device, pursuant to part 15 of the FCC Rules. These limits are designed to provide reasonable protection against harmful interference when the equipment is operated in a commercial environment. This equipment generates, uses, and can radiate radio frequency energy and, if not installed and used in accordance with the instruction manual, may cause harmful interference to radio communications. Operation of this equipment in a residential area is likely to cause harmful interference in which case the user will be required to correct the interference at his own expense.

■ **Recycling note**

After usage, this device must be disposed of properly as electronic waste, in accordance with the current disposal regulations of your county, state, and country.

About this Manual

The “Installation” user manual contains a device description, safety instructions, a description of the display, and the other information that you need to install the device.

The following manuals are available as PDF files for download on the Internet at <https://www.doc.hirschmann.com/>

- ▶ User Manual Installation
- ▶ User Manual Basic Configuration
- ▶ User Manual Redundancy Configuration
- ▶ Reference Manual Graphical User Interface
- ▶ Reference Manual Command Line Interface

The Network Management Software Industrial HiVision provides you with options for smooth configuration and monitoring. You find further information on the Hirschmann product pages on the internet: www.hirschmann.com/de/Hirschmann/Industrial_Ethernet/Netzmanagement/index.phtml

Key

The symbols used in this manual have the following meanings:

▶	Listing
□	Work step
■	Subheading

1 Description

1.1 General device description

You can choose from a wide range of variants. You have the option to set up your device individually based on different criteria:

- ▶ Number of ports
- ▶ Transmission speed
- ▶ Types of connectors
- ▶ Temperature range
- ▶ Supply voltage range
- ▶ Certifications

The device is designed for the special requirements of industrial automation. The device meets the relevant industry standards, provides very high operational reliability, even under extreme conditions, and also long-term reliability and flexibility.

The device allows you to set up switched Industrial Ethernet networks according to standard IEEE 802.3.

The device works without a fan.

The device is available with or without PoE functionality.

For devices without PoE, the voltage supply can be redundant if required.

The following installation options are available:

- ▶ 19" switch cabinet
- ▶ Mounting on a flat surface

You have the option of choosing various media to connect to the end devices and other network components:

- ▶ Twisted pair cable
- ▶ Multimode F/O
- ▶ Singlemode F/O

The ring redundancy concept allows the network to be reconfigured quickly after a failure.

Product configuration data can be provided by:

- ▶ diagnosis displays
- ▶ Display of the operating parameters

There are convenient options for managing the device. Manage your devices via:

- ▶ Web browser
- ▶ Telnet
- ▶ HiDiscovery (software for putting the device into operation)

- ▶ Network management software (for example Industrial HiVision)
- ▶ V.24 interface (locally on the device)

The device provides you with a large range of functions, which the manuals for the operating software inform you about. You can download these manuals as PDF files from the Internet at: <https://www.doc.hirschmann.com>
 The Hirschmann network components help you ensure continuous communication across all levels of the company.

1.2 Combination options

The product designation of your device is made from combining the desired product characteristics in accordance with the following table. The corresponding short designation is in column 3.

You have numerous options of combining the device characteristics. You can determine the possible combinations using the configurator which is available in the Belden Online Catalog <https://catalog.belden.com> on the web page of the device.

Position	Characteristic	Characteristic value	Property
1 ... 7	Product	MAR1020	MACH Ruggedized Fast Ethernet Switch
		MAR1030	MACH Ruggedized Gigabit Ethernet Switch
		MAR1022	MACH Ruggedized Fast Ethernet Switch with PoE ^{ab}
		MAR1032	MACH Ruggedized Gigabit Ethernet Switch with PoE ^{ab}
		MAR1120	MACH Ruggedized Fast Ethernet Switch, ports on the back
		MAR1130	MACH Ruggedized Gigabit Ethernet Switch, ports on the back
		MAR1122	MACH Ruggedized Fast Ethernet Switch, ports on the back and with PoE ^{ab}
		MAR1132	MACH Ruggedized Gigabit Ethernet Switch, ports on the back and with PoE ^{ab}
8	- (hyphen)	-	

Table 1: Combination options for the device variants of MACH1000

Position	Characteristic	Characteristic value	Property
9 ... 10	10/100/1000 Mbit/s ports 1 + 2 or 1 to 4	99	Not present (in MAR1020)
		CC	2 × Combo port (SFP slot: 100/1000 Mbit/s, alternatively twisted pair RJ45 socket: 10/100/1000 Mbit/s)
		4O	2 × 2 Gigabit Ethernet ports SFP slot 1000 Mbit/s
		4T	2 × 2 Gigabit Ethernet ports RJ45 10/100/1000 Mbit/s
		OT	2 × Gigabit Ethernet port SFP slot 1000 Mbit/s plus 2 × Gigabit Ethernet port RJ45 10/100/1000 Mbit/s
11 ... 12	10/100 Mbit/s ports 1 + 2 ^a	99	Module position empty
		TT	2 × Twisted pair TX, RJ45, 10/100 Mbit/s
		BB	2 × Multimode FX LC, 100 Mbit/s
		MM	2 × Multimode FX DSC, 100 Mbit/s
		JJ	2 × Multimode FX MTRJ, 100 Mbit/s
		NN	2 × Multimode FX ST, 100 Mbit/s
		VV	2 × Singlemode FX DSC, 100 Mbit/s
		UU	2 × Singlemode FX ST, 100 Mbit/s
		LL	2 × Singlemode Long Haul FX DSC, 100 Mbit/s
		GG	2 × Singlemode Long Haul FX DSC, 124.27 mi (200 km), 100 Mbit/s
		ZZ	2 × SFP slot, 100 Mbit/s
		RR	2 × Twisted pair TX, RJ45, 10/100 Mbit/s
		FF ^b	2 × Multimode FL ST, 10 Mbit/s
13 ... 14	10/100 Mbit/s ports 3 + 4		See 11 ... 12
15 ... 16	10/100 Mbit/s ports 5 + 6		See 11 ... 12
17 ... 18	10/100 Mbit/s ports 7 + 8		See 11 ... 12
19 ... 20	10/100 Mbit/s ports 9 + 10		See 11 ... 12
21 ... 22	10/100 Mbit/s ports 11 + 12		See 11 ... 12
23 ... 24	10/100 Mbit/s ports 13 + 14		See 11 ... 12
25 ... 26	10/100 Mbit/s ports 15 + 16		See 11 ... 12
27 ... 28	10/100 Mbit/s ports 17 + 18		See 11 ... 12
29 ... 30	10/100 Mbit/s ports 19 + 20		See 11 ... 12
31 ... 32	10/100 Mbit/s ports 21 + 22		See 11 ... 12
33 ... 34	10/100 Mbit/s ports 23 + 24		See 11 ... 12
35	Temperature range	S	Standard
		U	Extended
		F	Extended, Conformal Coating
36	Type of power supply unit 1	C	Specification of types
		G	
		L	
		M	

Table 1: Combination options for the device variants of MACH1000

Position	Characteristic	Characteristic value	Property
37	Type of power supply unit 2	9	Not present
		C	Specification of types
		G	
		L	
38	Approvals	H	CE, UL 508, ISA 12.12.01- Class I, Div. 2, GL, IEC 61850, IEEE 1613 Substation, EN 50121-4 Railway (along track), NEMA TS2
		T	CE, UL 508, ISA 12.12.01- Class I, Div. 2, EN 50121-4 Railway (along track), NEMA TS2, EN 50155 Railway (train) ^{cd}
39	Software variant	P	Professional

Table 1: Combination options for the device variants of MACH1000

- In device variants with PoE (Power over Ethernet), the first 4 ports can be twisted pair TX RJ45 10/100 Mbit/s (short designation TT) or twisted pair TX M12 10/100 Mbit/s (short designation RR), as desired. The other ports can be selected freely from the table. Power supply unit 2 is a PoE power supply unit (input voltage range position 37: G or M). Power supply unit 1 is freely selectable from the combination table.
- Device variants with PoE or with FL ports: no approval characteristic value T (EN 50155 railway (train)) present.
- Rated voltage for power supply unit characteristic value G and M: 110 V DC; for power supply unit characteristic value C and L: 36 V DC
- The railway standard EN 50155 is only met if the PoE power is limited to 15 W.

1.3 Description of the device variants

The device variants MAR1020-..., MAR1022-..., MAR1120-... and MAR1122-... are MACH1000 ruggedized switches without Gigabit ports and a selectable number (up to 24) of Fast Ethernet ports (10/100 Mbit/s) as required. You have the option to choose the media for the Fast Ethernet ports 1 ... 24 in pairs.

The devices MAR1120-... and MAR1122-... have an additional Fast Ethernet port on the front of the device that you can use for diagnostic purposes.

- ▶ The MAR1022-... devices support PoE according to IEEE 802.3af. Fast Ethernet-Ports 1 ... 4 are PoE ports.
- ▶ In the case of the MAR1120-... devices all cable outlets lead to the back, which means that the ports are arranged on the back of the device.
- ▶ The MAR1122-... devices support PoE according to IEEE 802.3af. Fast Ethernet-Ports 1 ... 4 are PoE ports. All cable outlets lead to the back, which means that the ports are arranged on the back of the device.

The device variants MAR1030-..., MAR1032-..., MAR1130-... and MAR1132-... are MACH1000 ruggedized switches with 2 × or 4 × Gigabit ports (10/100/1000 Mbit/s) and a selectable number (up to 24 ×) of Fast Ethernet ports (10/100 Mbit/s) as required. You have the option to choose the media for the Fast Ethernet ports 1 ... 24 in pairs. For device variants with 2 × Gigabit Ethernet ports, these are designed as combo ports (2 × SFP slot: 100/1000 Mbit/s, alternatively assignable: 2 × twisted pair RJ45 socket: 10/100/1000 Mbit/s). For device variants with 4 × Gigabit Ethernet ports, these are optionally designed as:

- ▶ 2 × 2 SFP slots
- ▶ 2 × 2 twisted pair RJ45 socket
- ▶ 2 × SFP slot plus 2 × twisted pair RJ45 socket

The devices MAR1130-... and MAR1132-... have an additional Fast Ethernet port on the front of the device that you can use for diagnostic purposes.

- ▶ The MAR1132-... devices support PoE (Power over Ethernet) according to IEEE 802.3af. Fast Ethernet-Ports 1 ... 4 are PoE ports.
- ▶ In the case of the MAR1130-... devices all cable outlets lead to the back, which means that the ports are arranged on the back of the device.
- ▶ The MAR1132-... devices support PoE (Power over Ethernet) according to IEEE 802.3af. Fast Ethernet-Ports 1 ... 4 are PoE ports. In these devices all cable outlets lead to the back, which means that the ports are arranged on the back of the device.

1.3.1 Port assignment

The port assignment pictured is exemplary. The sequence of the port numbering is identical for every device variant.

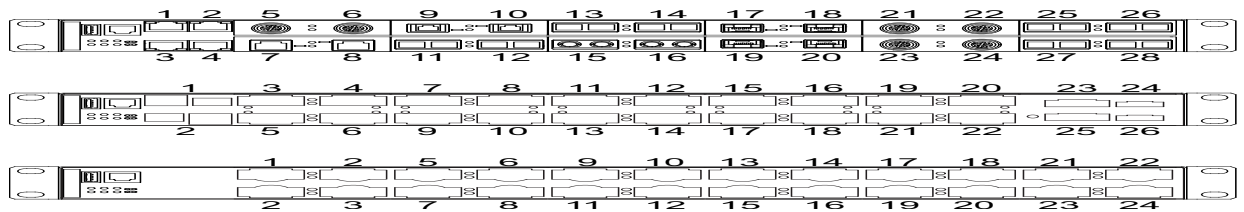

Figure 1: Port assignment: Example for port assignment

1.3.2 Front view MACH1000 with 2 × Gigabit ports

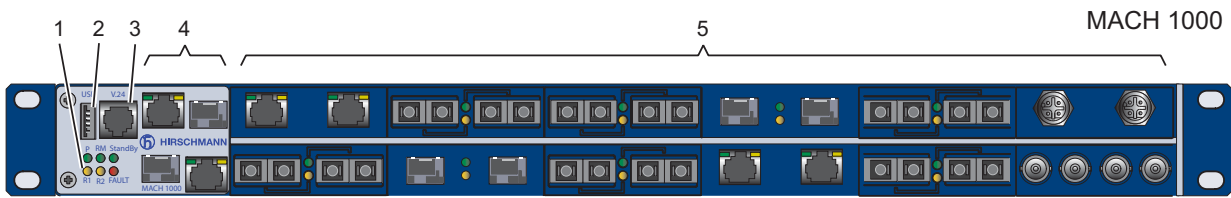

Figure 2: 1 - LED display elements
 2 - USB interface
 3 - V.24 connection for external management
 4 - See following table, column 1
 5 - See following table, column 2

Gigabit Ethernet GE ports 1 and 2 (combo ports)	Fast Ethernet FE ports 1 ... 24, connection as required
100/1000 Mbit/s	99: Module position empty
Fiber optic, SFP slots	TT: 2 × Twisted pair TX, RJ45, 10/100 Mbit/s
Alternative connections: 10/100/1000 Mbit/s	MM: 2 × Multimode FX DSC, 100 Mbit/s
Twisted pair, RJ45 connections	JJ: 2 × Multimode FX MTRJ, 100 Mbit/s
	NN: 2 × Multimode FX ST, 100 Mbit/s
	VV: 2 × Singlemode FX DSC, 100 Mbit/s
	UU: 2 × Singlemode FX ST, 100 Mbit/s
	LL: 2 × Singlemode Long Haul FX DSC, 100 Mbit/s
	GG: 2 × Singlemode Long Haul FX DSC, 124.27 mi (200 km),
	ZZ: 100 Mbit/s
	RR: 2 × SFP slot, 100 Mbit/s
	FF: 2 × Twisted pair TX, RJ45, 10/100 Mbit/s
	2 × Multimode FL ST, 10 Mbit/s

1.3.3 Front view MACH1000 with 4 × Gigabit ports (SFP)

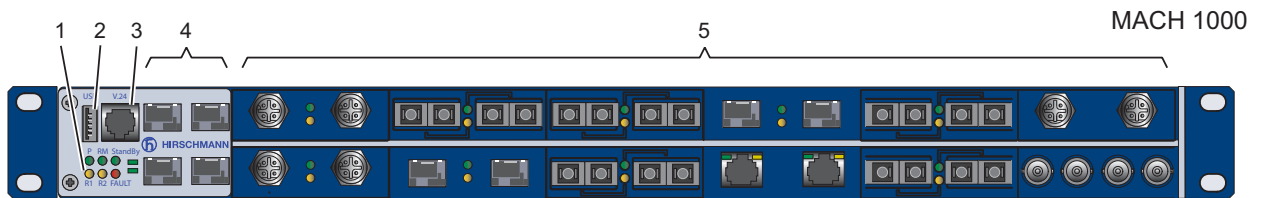

Figure 3: 1 - LED display elements
 2 - USB interface
 3 - V.24 connection for external management
 4 - See following table, column 1
 5 - See following table, column 2

Gigabit Ethernet GE ports 1 ... 4	Fast Ethernet FE ports 1 ... 24, connection as required
1000 Mbit/s	99: Module position empty
Fiber optic, SFP slots	TT: 2 × Twisted pair TX, RJ45, 10/100 Mbit/s
	MM: 2 × Multimode FX DSC, 100 Mbit/s
	JJ: 2 × Multimode FX MTRJ, 100 Mbit/s
	NN: 2 × Multimode FX ST, 100 Mbit/s
	VV: 2 × Singlemode FX DSC, 100 Mbit/s
	UU: 2 × Singlemode FX ST, 100 Mbit/s
	LL: 2 × Singlemode Long Haul FX DSC, 100 Mbit/s
	GG: 2 × Singlemode Long Haul FX DSC, 124.27 mi (200 km),
	ZZ: 100 Mbit/s
	RR: 2 × SFP slot, 100 Mbit/s
	FF: 2 × Twisted pair TX, RJ45, 10/100 Mbit/s
	2 × Multimode FL ST, 10 Mbit/s

1.3.4 Front view MACH1000 with 4 Gigabit ports (2 × SFP and 2 × RJ45)

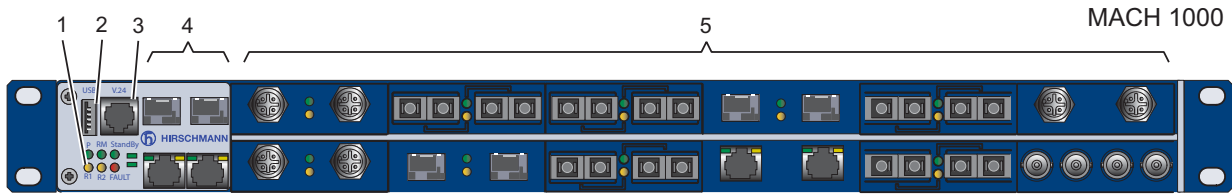

Figure 4: 1 - LED display elements
 2 - USB interface
 3 - V.24 connection for external management
 4 - See following table, column 1
 5 - See following table, column 2

Gigabit Ethernet GE ports 1 ... 4	Fast Ethernet FE ports 1 ... 24, connection as required
1000 Mbit/s	99: Module position empty
Fiber optic, SFP slots	TT: 2 × Twisted pair TX, RJ45, 10/100 Mbit/s
And / or:	MM: 2 × Multimode FX DSC, 100 Mbit/s
10/100/1000 Mbit/s	JJ: 2 × Multimode FX MTRJ, 100 Mbit/s
Twisted pair, RJ45 connections	NN: 2 × Multimode FX ST, 100 Mbit/s
	VV: 2 × Singlemode FX DSC, 100 Mbit/s
	UU: 2 × Singlemode FX ST, 100 Mbit/s
	LL: 2 × Singlemode Long Haul FX DSC, 100 Mbit/s
	GG: 2 × Singlemode Long Haul FX DSC, 124.27 mi
	ZZ: (200 km), 100 Mbit/s
	RR: 2 × SFP slot, 100 Mbit/s
	FF: 2 × Twisted pair TX, RJ45, 10/100 Mbit/s
	2 × Multimode FL ST, 10 Mbit/s

1.3.5 Front view MACH1000 with PoE

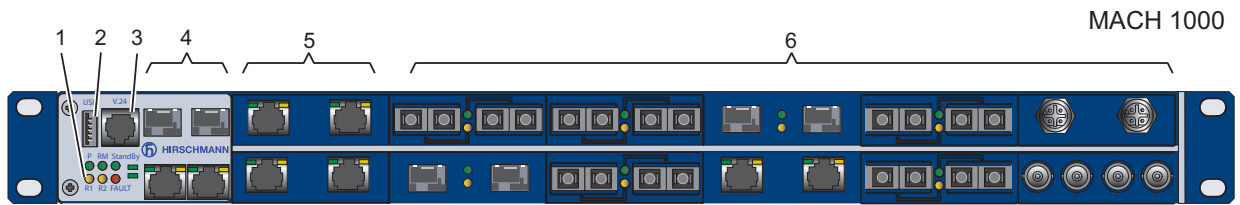

Figure 5: 1 - LED display elements
 2 - USB interface
 3 - V.24 connection for external management
 4 - See below [table 2](#), column 1
 5 - See below [table 2](#), column 2
 6 - See below [table 3](#)

Gigabit Ethernet Up to 4 × GE ports	Fast Ethernet FE ports 1 to 4, Power over Ethernet
1000 Mbit/s	TT: 2 * twisted pair TX, RJ45, 10/100 Mbit/s
Fiber optic, SFP slots	RR: 2 * twisted pair TX, M12, 10/100 Mbit/s
And / or:	
10/100/1000 Mbit/s	
Twisted pair, RJ45 connections	



Table 2: Gigabit Ethernet, Fast Ethernet FE ports 1 to 4

Fast Ethernet FE ports 5 ... 24, connection as required
99: Module position empty
TT: 2 × Twisted pair TX, RJ45, 10/100 Mbit/s
MM: 2 × Multimode FX DSC, 100 Mbit/s
JJ: 2 × Multimode FX MTRJ, 100 Mbit/s
NN: 2 × Multimode FX ST, 100 Mbit/s
VV: 2 × Singlemode FX DSC, 100 Mbit/s
UU: 2 × Singlemode FX ST, 100 Mbit/s
LL: 2 × Singlemode Long Haul FX DSC, 100 Mbit/s
GG: 2 × Singlemode Long Haul FX DSC, 124.27 mi (200 km), 100 Mbit/s
ZZ: 2 × SFP slot, 100 Mbit/s
RR: 2 × Twisted pair TX, RJ45, 10/100 Mbit/s
FF: 2 × Multimode FL ST, 10 Mbit/s

Table 3: Fast Ethernet, FE ports 5 to 24

1.3.6 Views MACH1000, ports on the back

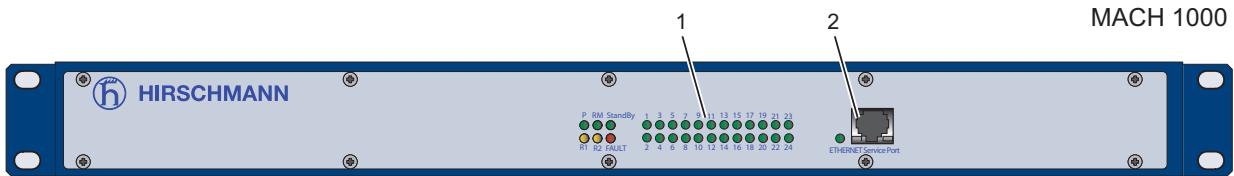

Figure 6: Front panel:
 1 - LED display elements
 2 - Diagnosis port

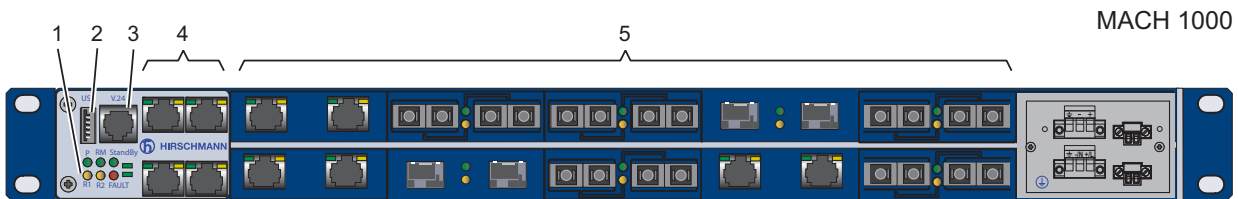

Figure 7: Rear side:
 1 - LED display elements
 2 - USB interface
 3 - V.24 access external management
 4 - See the following table, column 1
 5 - See the following table, column 2

Gigabit Ethernet Up to 4 × GE ports	Fast Ethernet FE ports 1 ... 20, connection as required
1000 Mbit/s	99: Module position empty
Fiber optic, SFP slots	TT: 2 × Twisted pair TX, RJ45, 10/100 Mbit/s
	MM: 2 × Multimode FX DSC, 100 Mbit/s
	JJ: 2 × Multimode FX MTRJ, 100 Mbit/s
And / or:	NN: 2 × Multimode FX ST, 100 Mbit/s
10/100/1000 Mbit/s	VV: 2 × Singlemode FX DSC, 100 Mbit/s
Twisted pair, RJ45 connections	UU: 2 × Singlemode FX ST, 100 Mbit/s
	LL: 2 × Singlemode Long Haul FX DSC, 100 Mbit/s
	GG: 2 × Singlemode Long Haul FX DSC, 124.27 mi (200 km),
	ZZ: 100 Mbit/s
	RR: 2 × SFP slot, 100 Mbit/s
	FF: 2 × Twisted pair TX, RJ45, 10/100 Mbit/s
	2 × Multimode FL ST, 10 Mbit/s

Device variants with ports on the rear have the following properties:

- ▶ The display LEDs are on the front of the device. There are up to 4 LEDs for displaying the status of the Gigabit Ethernet ports and up to 21 LEDs for displaying the status of the Fast Ethernet ports, as well as 6 LEDs for displaying the device status.
- ▶ The supply voltage connection and the ports are on the back of the device. The device allows you to connect a maximum of 20 Fast Ethernet ports as well as an additional Fast Ethernet port on the front of the device that you can use for diagnosis purposes.

1.3.7 Connections for voltage-carrying lines

The supply voltage is electrically isolated from the casing.

A device has one or two internal power supply units. Each power supply unit has a connection for the supply voltage and a connection for the signal contact.

The power supply unit types have the following different properties:

- ▶ Type of connections: terminal or plugged
- ▶ Type of supply voltages that can be connected: Direct voltage (DC) or alternating voltage (AC)
- ▶ Level of connectable supply voltages:

For devices without PoE featuring 2 power supply units, you can connect the supply voltage redundantly. Both inputs are uncoupled. With a non-redundant supply of the supply voltage, the device reports the loss of a supply voltage. You can prevent this message by applying the supply voltage via both inputs, or by changing the configuration in the Management.

Note: At positions 36 and 37 of the product code (see [table 1](#)) you find which power supply types your device has.

The following tables provide an overview of the possible connections for voltage-carrying lines:

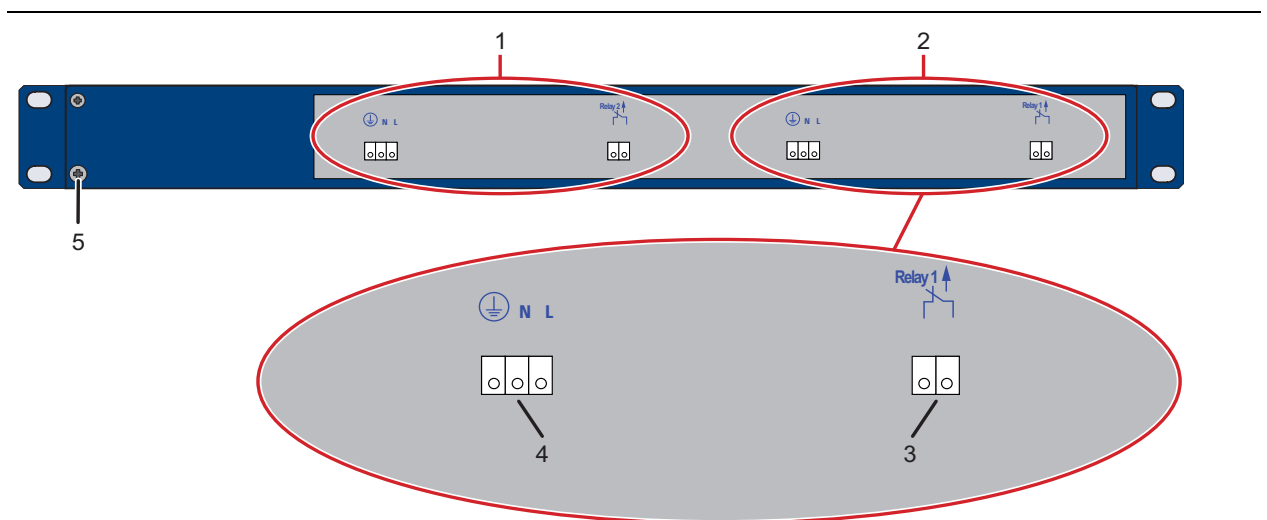

1	Power supply unit 2 ^a	Possible types:	C	DC voltage connectable
				Voltage range: See "General technical data" on page 53.
			G ^b	DC or AC voltage connectable
				Voltage range: See "General technical data" on page 53.
2	Power supply unit 1	Possible types:	C	See 1
			G	See 1

Table 4: Connections for voltage-carrying lines:
rear view of the device variants with terminal connections

3	Connection for the signal contact	▶ Spring-loaded terminal ▶ 2-pin
4	Supply voltage connection	▶ Spring-loaded terminal ▶ 3-pin
5	Grounding screw	

Table 4: Connections for voltage-carrying lines:
rear view of the device variants with terminal connections

- In devices without PoE, power supply unit 2 is optional. It is used for redundant voltage supply. In devices with PoE, power supply unit 2 is mandatory. It is only used to supply PoE voltage to the connected devices.
- For devices with PoE that have terminal connections, power supply unit 2 must be type “G”.

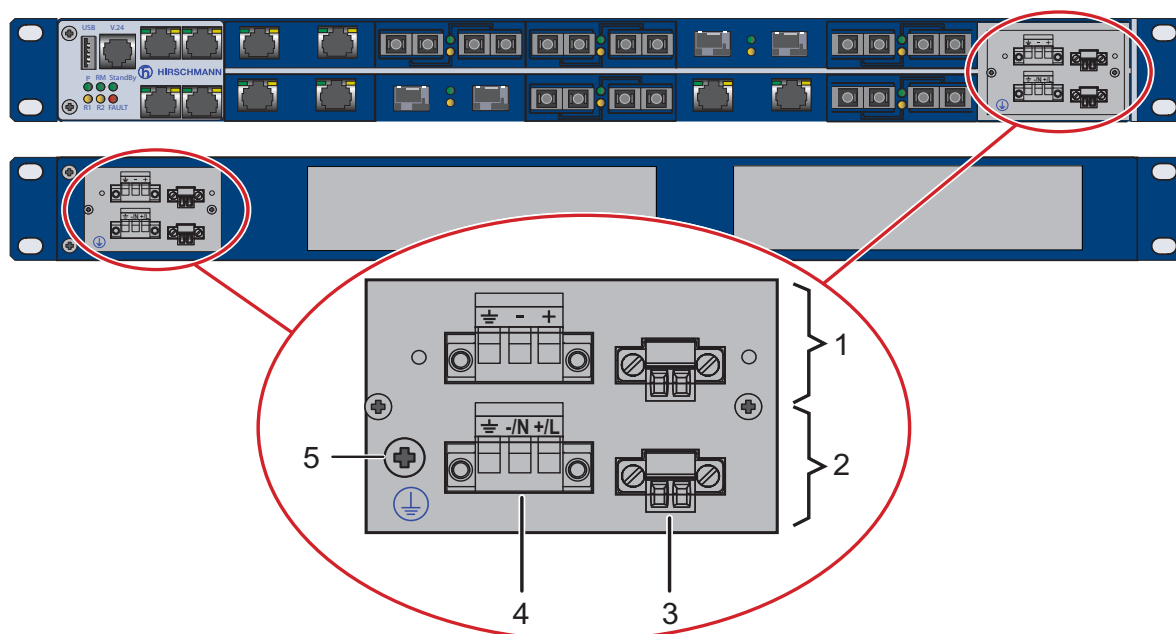

1	Power supply unit 2 ^a	Possible types:	L	DC voltage connectable Voltage range: See “General technical data” on page 53.
			M ^b	DC or AC voltage connectable Voltage range: See “General technical data” on page 53.
2	Power supply unit 1	Possible types:	L	See 1
			M	See 1
3	Connection for the signal contact	▶ Spring-loaded terminal ▶ 2-pin		
4	Supply voltage connection	▶ Spring-loaded terminal ▶ 3-pin		
5	Grounding screw			

Table 5: Connections for voltage-carrying lines:
rear view of the device variants with plugged connections (above: MAR11..., below: MAR10...)

- In devices without PoE, power supply unit 2 is optional. It is used for redundant voltage supply. In devices with PoE, power supply unit 2 is mandatory. It is only used to supply PoE voltage to the connected devices.
- For devices with PoE that have plugged connections, power supply unit 2 must be type “M”.

1.3.8 Support of PoE

The MACH 1000 device variants MAR1022-..., MAR1032-..., MAR1132-... and MAR 1132-... support Power over Ethernet (PoE) in accordance with IEEE 802.3af. They allow the connection and remote supply of, for example, IP telephones (Voice over IP), webcams, sensors, printer servers and WLAN access points via 10BASE-T/100BASE-TX. With PoE, these terminal devices are powered by the twisted-pair cable.

The MACH 1000 devices with PoE have 2*2 twisted pair ports TX 10/100 Mbit/s, depending on the device variant, as RJ45 or M12 sockets for connecting network segments or PoE terminal devices (PD, Powered Device) for all IEEE802.3af classes up to a maximum power output of 15.4 W.

The current is supplied on wire pairs transmitting the signal; the individual ports are not electrically insulated from each other.

The following conditions are met in accordance with IEEE 802.3af:

- ▶ Endpoint PSE
- ▶ Alternative A

The port casing is electrically connected to the front panel.

The PoE power is supplied via the wire pairs transmitting the signal (phantom voltage).

- Use a shielded CAT5 cable or better.
- Use a shielded 4-pin M12 plug.
- Connect the cable shield to the connector housing.

1.4 Ethernet ports

You can connect end devices and other segments to the device ports using twisted pair cables or optical fibers (F/O).

You find information on the pin assignments for making patch cables here: [“Pin assignments” on page 31](#)

1.4.1 10/100/1000 Mbit/s twisted pair port

This port is an RJ45 socket.

The 10/100/1000 Mbit/s twisted pair port allows you to connect network components according to the IEEE 802.3 10BASE-T/100BASE-TX/1000BASE-T standard.

This port supports:

- ▶ Autonegotiation
- ▶ Autopolarity
- ▶ Autocrossing (if autonegotiation is activated)

- ▶ 1000 Mbit/s full duplex
- ▶ 100 Mbit/s half-duplex mode, 100 Mbit/s full duplex mode
- ▶ 10 Mbit/s half-duplex mode, 10 Mbit/s full duplex mode

Delivery state: Autonegotiation activated

The port casing is electrically connected to the front panel.
The pin assignment corresponds to MDI-X.

1.4.2 10/100 Mbit/s twisted pair port

This port is an RJ45 socket.

The 10/100 Mbit/s twisted pair port allows you to connect network components according to the IEEE 802.3 10BASE-T/100BASE-TX standard.

This port supports:

- ▶ Autonegotiation
- ▶ Autopolarity
- ▶ Autocrossing (if autonegotiation is activated)
- ▶ 100 Mbit/s half-duplex mode, 100 Mbit/s full duplex mode
- ▶ 10 Mbit/s half-duplex mode, 10 Mbit/s full duplex mode

Delivery state: Autonegotiation activated

The port casing is electrically connected to the front panel.

Pin assignment of the RJ45 socket:

- One line pair: pin 3 and pin 6
- One line pair: pin 1 and pin 2
- Remaining pins: not used.

Note: In substation applications, the RJ45 ports are used to connect to additional communication devices such as routers or telecommunication multiplexers that are installed in close proximity to the device (<3 m). It is not recommended to use these ports for connection to field devices across longer distances which could cause a significant increase in the ground potential (Ground Potential Rise GPR, that means >2500 V).

1.4.3 1000 Mbit/s F/O port

This port is an SFP slot.

The 1000 Mbit/s F/O port offers you the ability to connect network components according to the IEEE 802.3 100BASE-SX/1000BASE-LX standard.

This port supports:

- ▶ Autonegotiation

Delivery state: Autonegotiation activated

Note: On the MACH1030 with 2 × 1000 Mbit/s F/O ports, these ports are combo ports (SFP/RJ45). You can use either the SFP slot or the RJ45 socket to connect data cables. If both are used, the assigned SFP slot switches off the related RJ45 port.

1.4.4 100 Mbit/s F/O port

This port is an ST, LC, DSC or MTRJ socket or an SFP slot.

The 100 Mbit/s F/O port allows you to connect network components according to the IEEE 802.3 100BASE-FX standard.

This port supports:

- ▶ Full or half duplex mode

Default setting: Full duplex

1.4.5 10 Mbit/s F/O port

This port is an ST socket.

The 10 Mbit/s F/O port offers you the ability to connect network components according to the IEEE 802.3 10BASE-FL standard.

This port supports:

- ▶ Full or half duplex mode

Default setting: Full duplex

1.4.6 Pin assignments

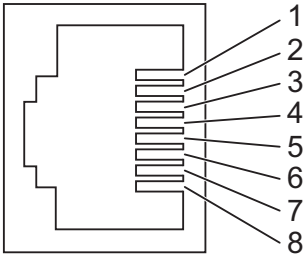
RJ45	Pin	10/100 Mbit/s	1000 Mbit/s	PoE
	MDI mode			
	1	TX+	BI_DA+	Positive V_{PSE}^a
	2	TX-	BI_DA-	Positive V_{PSE}^a
	3	RX+	BI_DB+	Negative V_{PSE}^a
	4	—	BI_DC+	Positive V_{PSE}^b
	5	—	BI_DC-	Positive V_{PSE}^b
	6	RX-	BI_DB-	Negative V_{PSE}^a
	7	—	BI_DD+	Negative V_{PSE}^b
	8	—	BI_DD-	Negative V_{PSE}^b
	MDI-X mode			
	1	RX+	BI_DB+	Negative V_{PSE}^a
	2	RX-	BI_DB-	Negative V_{PSE}^a
	3	TX+	BI_DA+	Positive V_{PSE}^a
	4	—	BI_DD+	Positive V_{PSE}^b
	5	—	BI_DD-	Positive V_{PSE}^b
	6	TX-	BI_DA-	Positive V_{PSE}^a
7	—	BI_DC+	Negative V_{PSE}^b	
8	—	BI_DC-	Negative V_{PSE}^b	

- a. Phantom supply
- b. Spare pair supply

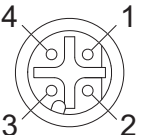
M12 4-pin ("D"-coded)	Pin	Data	PoE
	1	TX+	Positive V_{PSE}
	2	RX+	Negative V_{PSE}
	3	TX-	Positive V_{PSE}
	4	RX-	Negative V_{PSE}

1.5 Display elements

After the supply voltage is set up, the software starts and initializes itself. Afterwards, the device performs a self-test. During this process, various LEDs light up. The process takes around 60 seconds.

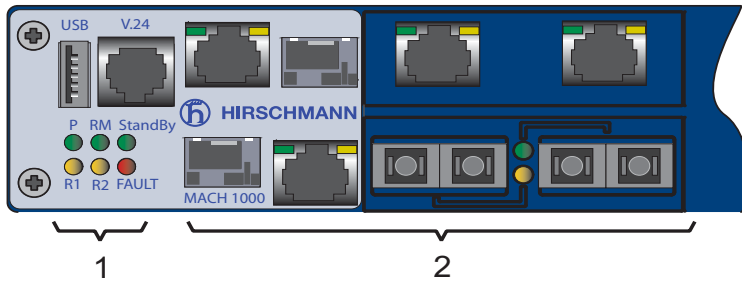

Figure 8: Display elements MACH1000, device variants with ports in front
1 - Display elements device status
2 - Display elements port status

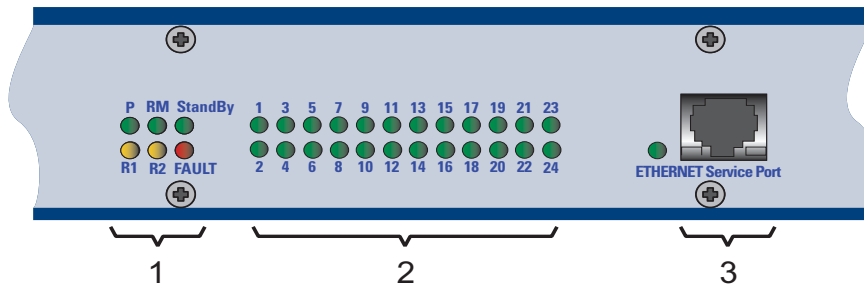

Figure 9: Display elements MACH1000, device variants with ports at the back
1 - Display elements device status
2 - Display elements port status for up to 4 × Gigabit Ethernet ports and up to 20 × Fast Ethernet ports
3 - Diagnostic port with display element

1.5.1 Device status

These LEDs provide information about conditions which affect the operation of the whole device.

The following table applies only to device variants with 2 power supply units:

LED	Display	Color	Activity	Meaning
P	Supply voltage		none	Supply voltages 1 and 2 are too low.
		green	lights up	Supply voltage 1 and 2 is on
		yellow	lights up	Supply voltage 1 or 2 is on

The following table applies only to device variants with one power supply unit:

LED	Display	Color	Activity	Meaning
P	Supply voltage		none	Supply voltage is too low
		green	lights up	Supply voltage is on

The following table applies to every device variant:

LED	Display	Color	Activity	Meaning
Stand-by	Stand-by mode		none	Stand-by mode not enabled
		green	lights up	Standby mode enabled
RM	Ring Manager		none	The RM function is deactivated.
		green	lights up	The RM function is active. The redundant port is disabled.
			flashing	The device detects an incorrect configuration of the HIPER-Ring (for example the ring is not connected to the ring port).
		yellow	lights up	The RM function is active. The redundant port is enabled.
RM and Stand-by	ACA memory operations		Flashing alternately	Error in the memory operation
			flashes synchronously 2 × per period	Saves a configuration file from the storage medium ACA to the device.
			flashes synchronously 1 × per period	Saves a configuration file from the device to the storage medium ACA.

Applies to software releases previous to 06.0.00:

LED	Display	Color	Activity	Meaning
FAULT	Signal contact 1	red	lights up	The signal contact is open - it is reporting a detected error.
			none	The signal contact is closed, it is not reporting any detected errors.

Applies to software release 06.0.00 and higher:

LED	Display	Color	Activity	Meaning
FAULT	Signal contact 1	red	lights up	The signal contact is open - it is reporting a detected error.
			none	The signal contact is closed, it is not reporting any detected errors.
	Duplicate IP detection	red	flashes 4 × a period	Reports an IP conflict.

Applies to software releases previous to 06.0.00:

LED	Display	Color	Activity	Meaning
R1	Signal contact 1	yellow	lights up	The signal contact is closed in manual operation.
			none	The signal contact is open in manual operation.
R2	Signal contact 2	yellow	lights up	The signal contact is closed in manual operation.
			none	The signal contact is open in manual operation.

Applies to software release 06.0.00 and higher:

LED	Display	Color	Activity	Meaning
R1	Signal contact 1	yellow	lights up	The signal contact is open.
			none	The signal contact is closed.
R2	Signal contact 2	yellow	lights up	The signal contact is open.
			none	The signal contact is closed.

If the manual setting is active on the signal contact, then the error display is independent of the setting of the signal contact.

1.5.2 Port status

The green and yellow LEDs at the individual port display port-related information. During the boot phase, these LEDs are used to display the status of the boot procedure.

LS - Data, Link Status (1 green/yellow LED or 1 green and 1 yellow LED)	
Not glowing	No valid connection.
Glowing green	Valid connection.
Flashing green (1 × a period)	Port is switched to stand-by.
Flashing green (3 × a period)	Port is disabled.
Flashing yellow	Data reception.

1.6 Management interfaces

1.6.1 V.24 interface (external management)

The V.24 interface is an RJ11 socket.

The V.24 user interface is serial and allows you to connect the following devices directly:

- ▶ External management station (VT100 terminal or PC with appropriate terminal emulation). With this management station, the Command Line Interface (CLI) is available to you. Furthermore, the system monitor is available to you at the system start.

VT100 terminal settings	
Speed	9600 Baud
Data	8 bit
Stopbit	1 bit
Handshake	off
Parity	none

The interface casing is electrically connected to the front panel.

The V.24 interface is not electrically insulated from the supply voltage.

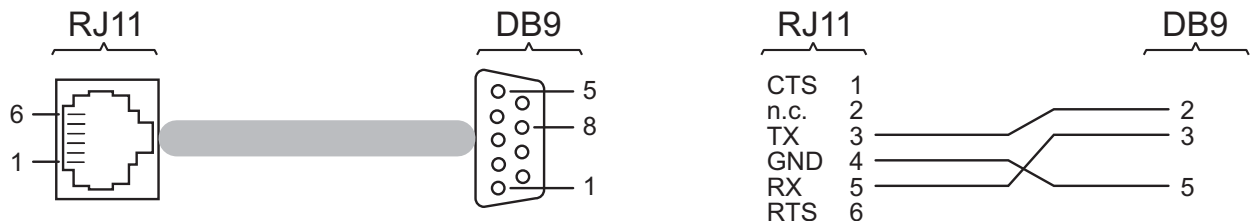

Figure 10: Pin assignment of the V.24 interface and the DB9 plug

Note: You will find the order number for the terminal cable, which is ordered separately, in the Technical Data section ([see on page 53 “Technical data”](#)).

You will find a description of the V.24 interface in the “User Manual Basic Configuration” document.

You find these manuals as PDF files on the Internet at <http://www.doc.hirschmann.com>

1.6.2 USB interface

The USB interface allows you to connect the AutoConfiguration Adapter ACA22 storage medium. This is used for saving/loading the configuration data and diagnostic information, and for loading the software.

Figure	Pin	Function
	1	VCC (VBus)
	2	- Data
	3	+ Data
	4	Ground (GND)

Table 6: Pin assignment of the USB interface

1.7 Signal contact

Depending on the device variant (equipped with one or two power supply units), one or two signal contacts are available.

- ▶ The signal contact is a potential-free relay contact.
The device allows you to perform remote diagnosis via the signal contact. In the process, the device signals events such as a line interruption. When an event occurs, the device opens the relay contact and interrupts the closed circuit. The management setting specifies which events switch a contact.
You can also use the management to switch the signal contact manually and thus control external devices.
- ▶ You can use the Management to set the signal contact manually and thus control external devices.

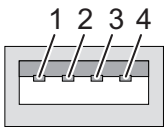
The potential-free signal contact (relay contact, closed circuit) reports through a break in contact:

- ▶ At least one power supply is inoperable.
- ▶ The device is not operational.
- ▶ The failure of the connection on at least one port.
The report of the link status can be masked by the Management for each port. In the delivery state is deactivated.
- ▶ Loss of the ring redundancy reserve.
- ▶ A detected error during the self-test.
- ▶ Incorrect configuration of the HIPER-Ring or ring coupling.
- ▶ Permitted temperature range exceeded/not reached.

The following condition is also reported in RM mode:

- ▶ Ring redundancy reserve is available. On delivery, there is no ring redundancy monitoring.

Note: The signal contact functions are available when the power supply is connected. If a redundant power supply is present but switched off, contact interruption occurs at the associated signal contact.

2 Installation

The devices have been developed for practical application in a harsh industrial environment.

On delivery, the device is ready for operation.

Perform the following steps to install and configure the device:

- ▶ [Checking the package contents](#)
- ▶ [Installing an SFP transceiver \(optional\)](#)
- ▶ [“Wiring of the terminal blocks for supply voltage and signal contact”](#)
- ▶ [Installing and grounding the device](#)
- ▶ [Operating the device](#)
- ▶ [Connecting data cables](#)

2.1 Checking the package contents

- Check whether the package includes all items named in the section [“Scope of delivery” on page 63](#).
- Check the individual parts for transport damage.

2.2 Installing an SFP transceiver (optional)

Prerequisites:

Exclusively use Hirschmann SFP transceivers.

See “Accessories” on page 63.

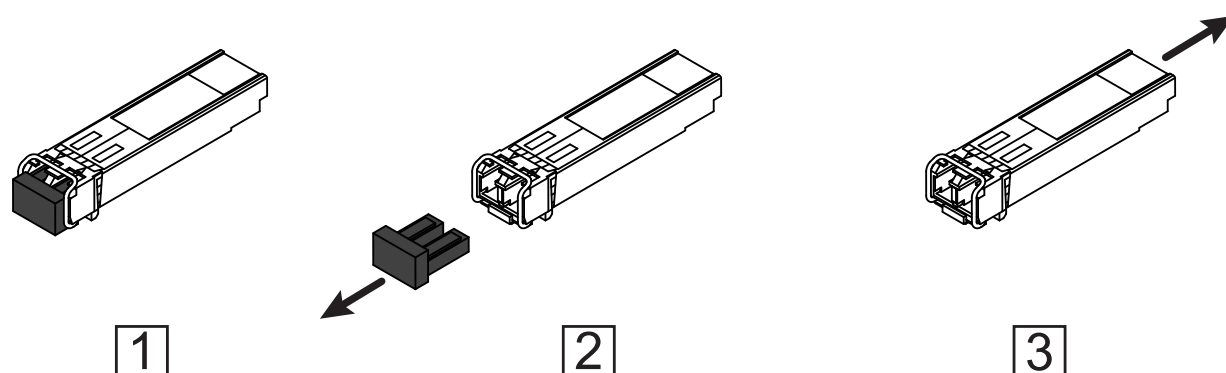

Figure 11: Installing SFP transceivers: Installation sequence

Perform the following work steps:

- Take the SFP transceiver out of the transport packaging (1).
- Remove the protection cap from the SFP transceiver (2).
- Push the SFP transceiver with the lock closed into the slot until it latches in (3).

2.3 Wiring of the terminal blocks for supply voltage and signal contact

2.3.1 Connecting the voltage supply terminals (power supply units “C” and “G”)

WARNING

ELECTRIC SHOCK

Connect only a supply voltage that corresponds to the type plate of your device.

Failure to follow these instructions can result in death, serious injury, or equipment damage.



Note: Note the permitted voltage ranges for devices with certification type “T” (EN 50155 railway (train) - see product code position 38 in [table 1](#)).

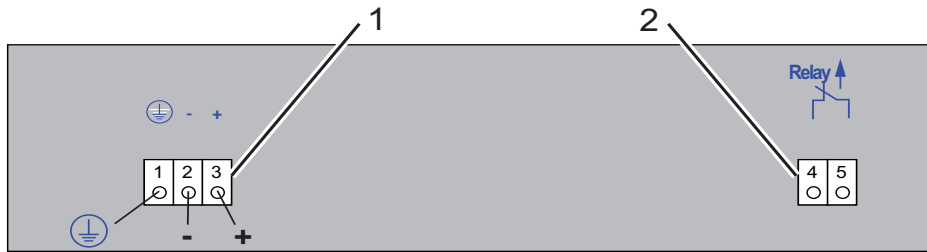

Figure 12: Power supply unit C, DC voltage ([“General technical data” on page 53](#))

Connecting
 1 - Supply voltage
 2 - Signal contact

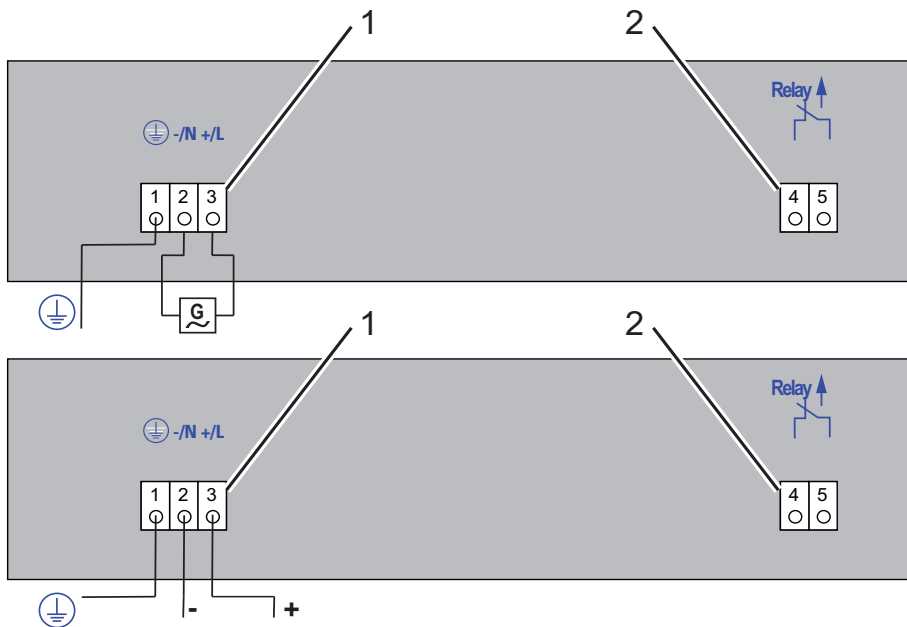

Figure 13: Power supply unit G ([see on page 53 “General technical data”](#)):

AC voltage (pictured above) or DC voltage (pictured below)
 Connecting
 1 - Supply voltage
 2 - Signal contact

Connection	Type “C”	Type “G” VDC	Type “G” VAC
\perp , pin 1	Protective conductor	Protective conductor	Protective conductor
-/N, pin 2	Minus terminal of the supply voltage	Minus terminal of the supply voltage	Neutral conductor
+/L, pin 3	Plus terminal of the supply voltage	Plus terminal of the supply voltage	Line conductor

Table 7: Pin assignment of spring-loaded terminal for voltage supply

Note: Use copper wire with cross-section AWG 16 to AWG 12 (0.75 mm² to 3.0 mm²) and stripping length 12 mm.

For **every** supply voltage to be connected, perform the following steps:

- Verify the required conditions for connecting the voltage supply.
[See “Supply voltage” on page 7.](#)
- To insert the cable, you open the terminal lock by positioning the screwdriver as illustrated below and pressing on the lever.
- Connect the protective conductor with the clamp.

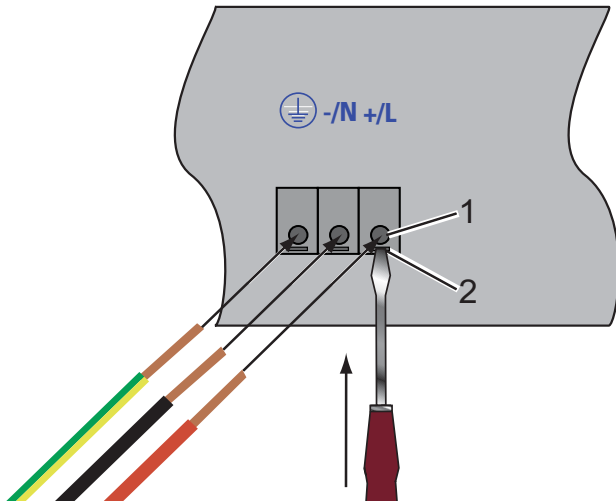

*Figure 14: Connecting the supply voltage via the 3-pin spring-loaded terminal
1 - Field connection terminal for supply voltage
2 - Terminal lock*

- Connect the wires according to the pin assignment on the device with the clamps.

2.3.2 Connecting the plugged voltage supply (power supply units “L” and “M”)

WARNING

ELECTRIC SHOCK

Connect only a supply voltage that corresponds to the type plate of your device.

Failure to follow these instructions can result in death, serious injury, or equipment damage.



Note: Note the permitted voltage ranges for devices with certification type “T” (EN 50155 railway (train) - see product code position 38 in [table 1](#)).

Relevant for North America:

The torque for tightening the supply voltage terminal block on the device is 0.51 Nm (4.5 lb-in).

The terminal blocks for devices with power supply unit characteristic value M or L are coded to prevent them from being accidentally connected to devices with power supply unit characteristic value L or M.

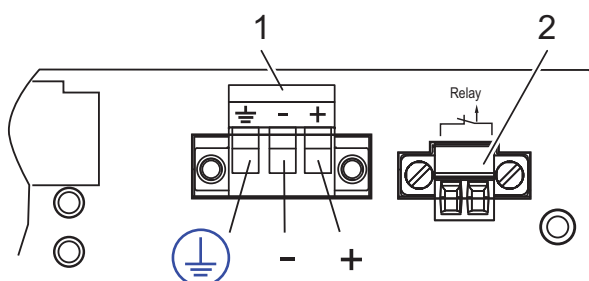

Figure 15: Power supply unit supply voltage characteristic value L, DC voltage (see on page 53 “General technical data”)

Connecting

1 - Supply voltage

2 - Signal contact

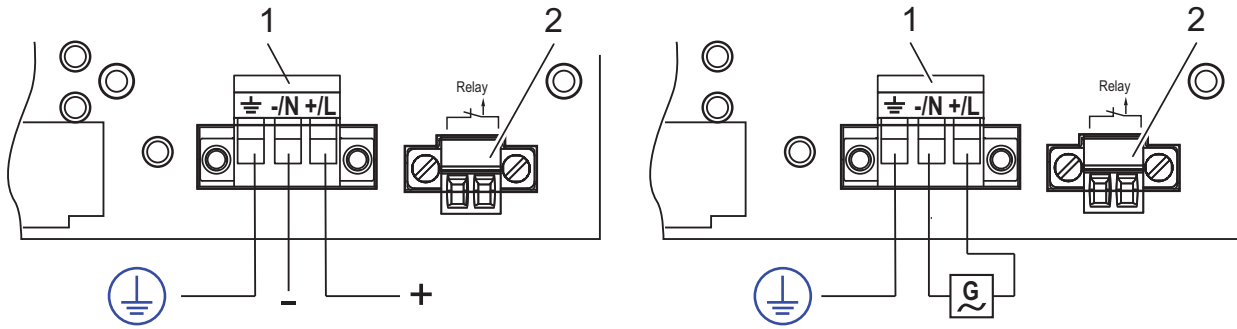

Figure 16: Power supply unit supply voltage characteristic value M (see on page 53 “General technical data”):

AC voltage (right figure) or DC voltage (left figure)

Connecting

1 - Supply voltage

2 - Signal contact

Connection	Power supply characteristic value L	Power supply characteristic value M - V DC	Power supply characteristic value M - V AC
⏚, pin 1	Protective conductor	Protective conductor	Protective conductor
-/N, pin 2	Minus terminal of the supply voltage	Minus terminal of the supply voltage	Neutral conductor
+/L, pin 3	Plus terminal of the supply voltage	Plus terminal of the supply voltage	Line conductor

Table 8: Pin assignment of terminal block for voltage supply

For **every** supply voltage to be connected, perform the following steps:

- Verify the required conditions for connecting the voltage supply.
See “Supply voltage” on page 7.
- Remove the terminal connector from the device.
- Connect the protective conductor with the clamp.
- Connect the wires according to the pin assignment on the device with the clamps.
- Mount the terminal block on the device using screws.

2.3.3 Wiring the signal contact

Relevant for North America:

The torque for tightening the terminal block for the signal contact on the device is 0.34 Nm (3 lb-in).

Note: Use copper wire with cross-section AWG 20 to AWG 12 (0.5 mm² to 3.0 mm²) and stripping length 12 mm.

For every signal contact to be connected, make sure the following requirements are met:

- ▶ The electrical wires are voltage-free.
- ▶ The connected voltage is limited by a current limitation device or a fuse. Observe the electrical threshold values for the signal contact.

See [“General technical data” on page 53](#).

Perform the following steps for the signal contacts to be connected:

- For plugged connections: connect the signal contact lines with the terminal block connections. Mount the terminal block on the device using screws.
- To insert the cable, you open the terminal lock by positioning the screwdriver as illustrated below and pressing on the lever.
- For terminal connections: connect the signal contact lines to the connection terminals.

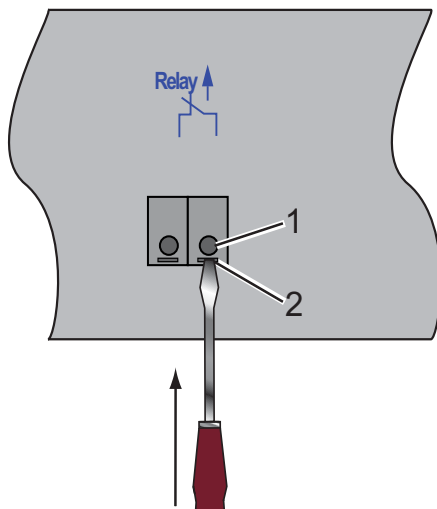

*Figure 17: Connecting the switching voltage via the 2-pin spring-loaded terminal
1 - Field connection terminal for switching voltage
2 - Terminal lock*

2.4 Installing and grounding the device



WARNING

ELECTRIC SHOCK

Install this device only in a switch cabinet or in an operating site with restricted access, to which maintenance staff have exclusive access.

Failure to follow this instruction can result in death, serious injury, or equipment damage.

Note: The shielding ground of the connectable twisted pair cables is connected to the front panel as a conductor.

2.4.1 Mounting in a switch cabinet

Install the device in the 19" switch cabinet using sliding or mounting rails. This provides a more stable position of your device in environments subject to vibration.

For more information on sliding/mounting rails and how to install them, please contact your switch cabinet manufacturer.

The devices are designed to be mounted in a 19" switch cabinet.

- Ensure adequate ventilation. If necessary, install an additional fan in the switch cabinet to prevent the device from overheating.
- Measure the depth of the 19" cabinet so that all the lines to be connected can be fed in easily.
- Assemble the sliding or mounting rails in the 19" switch cabinet as specified by the manufacturer.

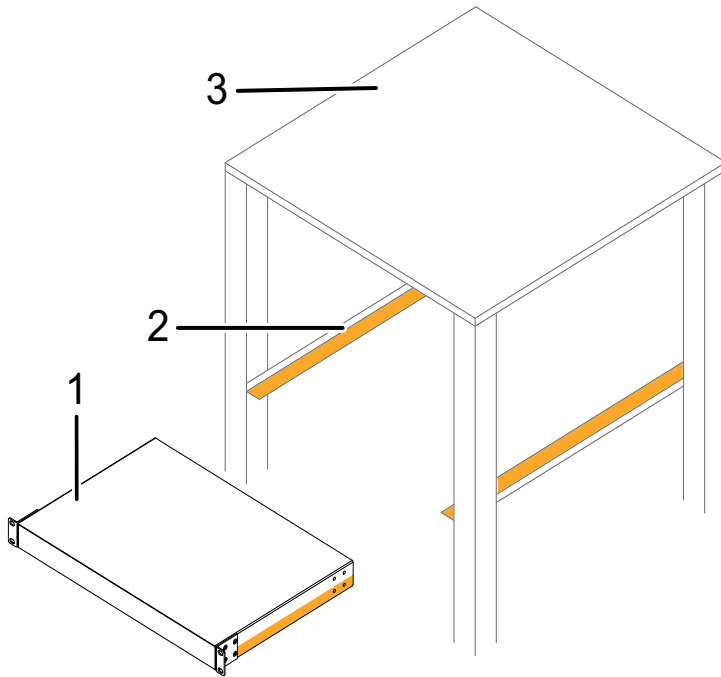

Figure 18: Assembly in a switch cabinet with sliding/mounting rails
 1 - MACH1000 device
 2 - sliding/mounting rail
 3 - 19" switch cabinet

On delivery, 2 mounting brackets are mounted to the sides of the device (see figure below).

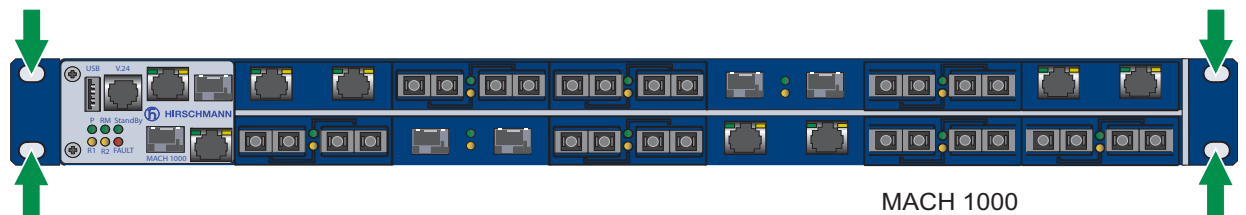

Figure 19: Mounting in the switch cabinet

- Fasten the device in the switch cabinet by screwing it in with the mounting brackets.

Note: When operating the device in an environment with strong vibrations, you have the option to additionally fasten the device to the switch cabinet using 2 holding brackets on the back of the device. You obtain the additional brackets as accessories.

See [“Accessories” on page 63](#).

2.4.2 Vertical mounting on the wall

WARNING

FIRE HAZARD

Install the device in a fire enclosure according to IEC/EN 62368-1 if you install the device vertically.

Failure to follow these instructions can result in death, serious injury, or equipment damage.

- Move the two pre-installed mounting brackets into the position shown below.

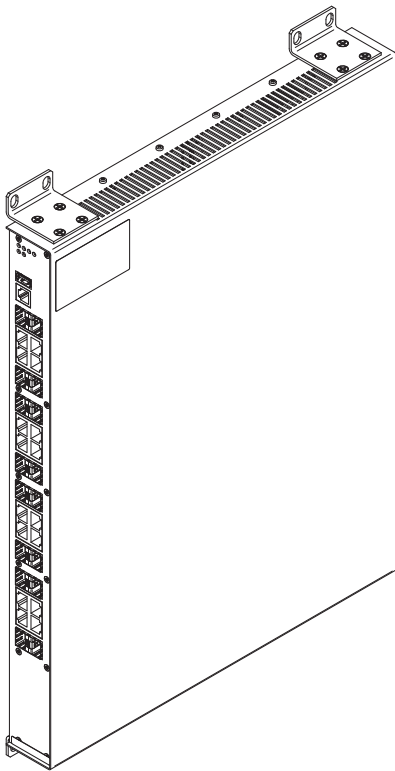

- Additionally attach 2 brackets to the back of the device. You obtain the additional brackets as accessories. [See “Accessories” on page 63.](#)
- Fasten the device by screwing the brackets to the wall.

2.4.3 Grounding the device

The device is grounded via the separate grounding screw on the back of the device.

2.5 Operating the device

When you connect the supply voltage, you start up the device.

2.6 Connecting data cables

You can connect end devices and other segments to the device ports using twisted pair cables or optical fibers (F/O).

Note the following general recommendations for data cable connections in environments with high electrical interference levels:

- Keep the length of the data cables as short as possible.
- Use optical data cables for the data transmission between the buildings.
- When using copper cables, provide a sufficient separation between the power supply cables and the data cables. Ideally, install the cables in separate cable channels.
- Verify that power supply cables and data cables do not run parallel over longer distances. To reduce inductive coupling, verify that the power supply cables and data cables cross at a 90 ° angle.
- Use shielded data cables for gigabit transmission via copper cables, for example SF/UTP cables according to ISO/IEC 11801. To meet EN 50121-4 and marine application requirements, use shielded data cables at all transmission rates.
- Connect the data cables according to your requirements.
[See “Ethernet ports” on page 29.](#)

2.6.1 Twisted Pair ports

- Connect the data cables according to your requirements.
[See “10/100/1000 Mbit/s twisted pair port” on page 29.](#)
[See “10/100 Mbit/s twisted pair port” on page 30.](#)

2.6.2 Optical fiber ports

Verify that you connect LH ports only with LH ports, SX ports only with SX ports, and LX ports only with LX ports.

- Connect the data cables according to your requirements.
[See “1000 Mbit/s F/O port” on page 30.](#)
[See “100 Mbit/s F/O port” on page 31.](#)
[See “10 Mbit/s F/O port” on page 31.](#)

3 Making basic settings

The IP parameters must be entered when the device is installed for the first time. The device provides 6 options for configuring the IP addresses:

- ▶ Entry via V.24 connection
- ▶ Entry using the HiDiscovery protocol via the HiDiscovery or Industrial HiVision application
- ▶ Configuration via BOOTP
- ▶ Configuration via DHCP
- ▶ Configuration via DHCP (Option 82)
- ▶ AutoConfiguration Adapter

You will find more information in the “Basic Configuration User Manual”.

You find these manuals as PDF files on the Internet at <http://www.doc.hirschmann.com>

■ Default settings

- ▶ IP address: The device looks for the IP address using DHCP
- ▶ Password for management:
Login: user; password: public (read only)
Login: admin; password: private (read and write)
- ▶ Parameters that can be set via the management are set to pre-defined values in accordance with the MIB
- ▶ V.24 data rate: 9600 Baud
- ▶ Ring redundancy: disabled
- ▶ Ethernet ports: link status is not evaluated (signal contact)
- ▶ Optical 100 Mbit/s ports: 100 Mbit/s full duplex
All other ports: autonegotiation
- ▶ Ring manager disabled
- ▶ Stand-by coupling: disabled
Port 4 = control port, port 3 = coupling port for red. Ring coupling

3.1 First login (Password change)

To help prevent undesired access to the device, it is imperative that you change the default password during initial setup.

Perform the following steps:

- Open the Graphical User Interface, the Command Line Interface, or HiView the first time you log on to the device.
- Log on to the device with the default password “private”. The device prompts you to type in a new password.
- Type in your new password.
To help increase security, choose a password that contains at least 8 characters which includes upper-case characters, lower-case characters, numerical digits, and special characters.
- When you log on to the device with the Command Line Interface, then the device prompts you to confirm your new password.
- Log on to the device again with your new password.

Note: If you lost your password, then use the System Monitor to reset the password.

For further information see:

<https://hirschmann-support.belden.com/en/kb/required-password-change-new-procedure-for-first-time-login>

4 Monitoring the ambient air temperature

Operate the device below the specified maximum ambient air temperature exclusively.

See [“General technical data” on page 53](#).

The ambient air temperature is the temperature of the air at a distance of 5 cm (2 in) from the device. It depends on the installation conditions of the device, for example the distance from other devices or other objects, and the output of neighboring devices.

The temperature displayed in the CLI (Command Line Interface) and the GUI (Graphical User Interface) is the internal temperature of the device. It is higher than the ambient air temperature. The maximum internal temperature of the device named in the technical data is a guideline that indicates to you that the maximum ambient air temperature has possibly been exceeded.

5 Maintenance and service

- When designing this device, Hirschmann largely avoided using high-wear parts. The parts subject to wear and tear are dimensioned to last longer than the lifetime of the product when it is operated normally. Operate this device according to the specifications.
- Relays are subject to natural wear. This wear depends on the frequency of the switching operations. Check the resistance of the closed relay contacts and the switching function depending on the frequency of the switching operations.
- Hirschmann is continually working on improving and developing their software. Check regularly whether there is an updated version of the software that provides you with additional benefits. You find information and software downloads on the Hirschmann product pages on the Internet (<http://www.hirschmann.com>).
- Depending on the degree of pollution in the operating environment, check at regular intervals that the ventilation slots in the device are not obstructed.

Note: You find information on settling complaints on the Internet at <http://www.beldensolutions.com/en/Service/Repairs/index.phtml>.

6 Disassembly

6.1 Removing the device

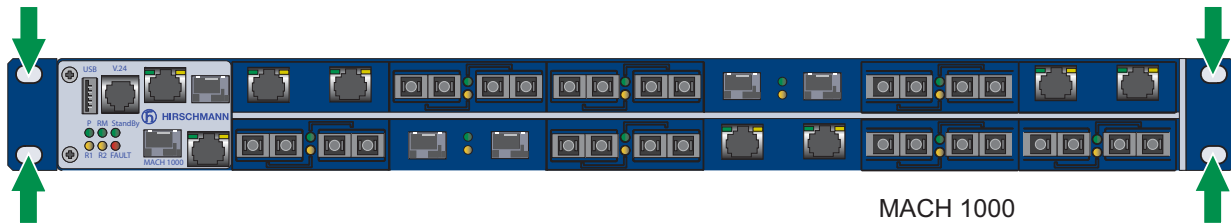

Perform the following work steps:

- Disconnect the data cables.
- Disable the supply voltage.
- Disconnect the grounding.
- To detach the device from the switch cabinet or the wall, remove the screws from the brackets on the device.

6.2 Removing an SFP transceiver (optional)

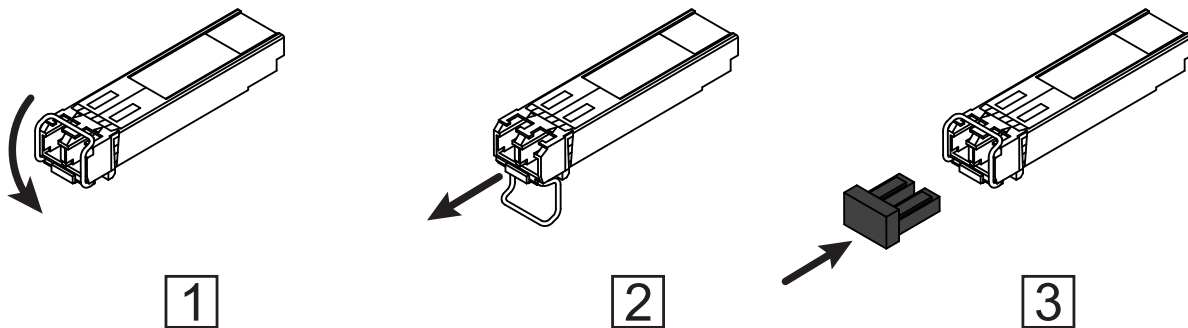

Figure 20: De-installing SFP transceivers: De-installation sequence

Perform the following work steps:

- Open the locking mechanism of the SFP transceiver (1).
- Pull the SFP transceiver out of the slot via the open locking mechanism (2).
- Close the SFP transceiver with the protection cap (3).

7 Technical data

■ General technical data

Dimensions W × H × D	Devices with terminal connection voltage supply (power unit types C and G)	448 × 310 × 44 mm (without brackets)
	Devices with pluggable voltage supply (power unit types T and M)	448 × 345 × 44 mm (without brackets)
Weight (incl. redundant power supply or PoE power supply)	MAR1020-... fully equipped	max. 4.6 kg (10.14 lb)
	MAR1030-... fully equipped	max. 4.7 kg (10.36 lb)
	MAR1120-... fully equipped (incl. redundant power unit)	max. 5.4 kg (11.9 lb)
	MAR1130-... fully equipped (incl. redundant power unit)	max. 5.5 kg (12.13 lb)
	MAR1122-... fully equipped	max. 5.5 kg (12.13 lb)
	MAR1132-... fully equipped	max. 5.6 kg (12.35 lb)
	MAR1022-... fully equipped	max. 4.7 kg (10.36 lb)
	MAR1032-... fully equipped	max. 4.8 kg (10.58 lb)
Weight	MAR1020-... basic device	approx. 3.9 kg (8.6 lb)
	MAR1030-... basic device	approx. 4.0 kg (8.82 lb)
	MAR1120-... basic device	approx. 4.7 kg (10.36 lb)
	MAR1130-... basic device	approx. 4.8 kg (10.58 lb)
	MAR1122-... basic device	approx. 5.1 kg (11.24 lb)
	MAR1132-... basic device	approx. 5.2 kg (11.46 lb)
	MAR1022-... basic device	approx. 4.3 kg (9.5 lb)
	MAR1032-... basic device	approx. 4.4 kg (9.7 lb)
	Optional PoE power unit	approx. 0.3 kg (0.66 lb)
	Optional second power unit	additional approx. 0.3 kg (0.66 lb)
	Per 6 ports (3 modules)	additional approx. 0.1 kg (0.22 lb)
	Per M12 module	additional approx. 0.09 kg (0.2 lb)
Power supply types G and M	Rated voltage range	100 V AC ... 240 V AC, 50 Hz ... 60 Hz 110 V DC ... 250 V DC ^a Devices with certification type "T": 110 V
	Voltage range including maximum tolerances	90 V AC ... 265 V AC, 47 Hz ... 63 Hz 77 V DC ... 300 V DC ^b
	Connection type G	3-pin spring-loaded terminal for copper wire with cross-section 0.5 mm ² ... 3.0 mm ² (AWG20 ... AWG12) and stripping length 12 mm (0.47 in)
	Connection type M	3-pin terminal block
	Power loss buffer	> 20 ms at 230 V AC
	Peak inrush current	14 A

Power supply types C and L	Rated voltage range	24 V DC ... 48 V DC Devices with certification type "T": 36 V	
	Voltage range incl. maximum tolerances	18 V DC ... 60 V DC	
	Connection type C	3-pin spring-loaded terminal for copper wire with cross-section AWG 20-12 (0.5 mm ² ... 3.0 mm ²) and stripping length 12 mm	
	Connection type L	3-pin terminal block	
	Power loss buffer	> 10 ms at 20.4 V DC	
	Peak inrush current	15 A	
Input voltage for device variants with PoE	Rated voltage range	110 V DC ... 250 V DC ^c 110 V AC ... 230 V AC	
	Voltage range incl. maximum tolerances	77 V DC ... 300 V DC ^d 90 V AC ... 265 V AC, 47 Hz ... 63 Hz	
Output voltage for device variants with PoE	48 V DC ± 5%		
Back-up fuse	Supply voltage characteristic value C and L	Nominal rating:	6.3 A
		Characteristic:	slow blow
	Supply voltage characteristic value G and M	Nominal rating:	2.5 A
		Characteristic:	slow blow
Connection type for power unit types C and G	2-pin spring-loaded terminal for copper wire with cross-section AWG 20-12 (0.5 mm ² ... 3.0 mm ²) and stripping length 12 mm		
Connection type for power supply units characteristic value L and M	2-pin terminal block		
Climatic conditions during operation	Minimum clearance around the device	Top and bottom sides of device: 2 in (5 cm) Left and right device side: 3.94 in (10 cm)	
	Ambient air temperature ^e	Standard	0 °C ... +60 °C (+32 °F ... +140 °F)
		Extended ^{fghij}	-40 °C ... +85 °C (-40 °F ... +185 °F)
	Humidity	5 % ... 95 % (non-condensing)	
	Air pressure	min. 795 hPa (+2000 m ASL; +6562 ft ASL), higher altitudes upon request	
Climatic conditions during storage	Ambient air temperature ^a	Standard	-40 °C ... +85 °C (-40 °F ... +185 °F)
		Extended	-40 °C ... +85 °C (-40 °F ... +185 °F)
	Humidity	5 % ... 95 % (non-condensing)	
	Air pressure	min. 795 hPa (+2000 m ASL; +6562 ft ASL), higher altitudes upon request	
Pollution degree	2		
Protection classes	Laser protection	Class 1 according to EN 60825-1	
	Degree of protection	IP30	

a. Not under UL 508/UL 60950 conditions.

b. Not under UL 508/UL 60950 conditions.

c. Not under UL 508/UL 60950 conditions.

d. Not under UL 508/UL 60950 conditions.

e. Temperature of the ambient air at a distance of 5 cm (2 in) from the device

- f. If you use SFP modules without the extension “EEC”, then an operating temperature range of +32 °F ... +140 °F (0 °C ... +60 °C) (see on page 63 “Accessories”).
- g. For devices equipped with more than 14 FO ports, the maximum operating temperature decreases gradually. When equipped with 28 FO ports, the maximum operating temperature is +158 °F (+70 °C).
- h. MACH1000 device equipped with Fast Ethernet modules characteristic value GG (Singlemode Long Haul FX DSC 124.27 mi (200 km)): +32 °F ... +140 °F (0 °C ... +60 °C).
- i. -40 °F ... +185 °F (-40 °C ... +85 °C) for devices with PoE, for devices with FL ports and for devices with 4 × Gigabit Ethernet ports.
- j. Relevant for hazardous areas and approvals ISA 12.12.01 Class I Division 2, UL 508: The maximum operating temperature (ambient air) is +158 °F (+70 °C) for the device variants characteristic value U and F and +140 °F (+60 °C) for the device variant characteristic value S (see on page 9 “Use in Hazardous Locations”).

■ Dimension drawings

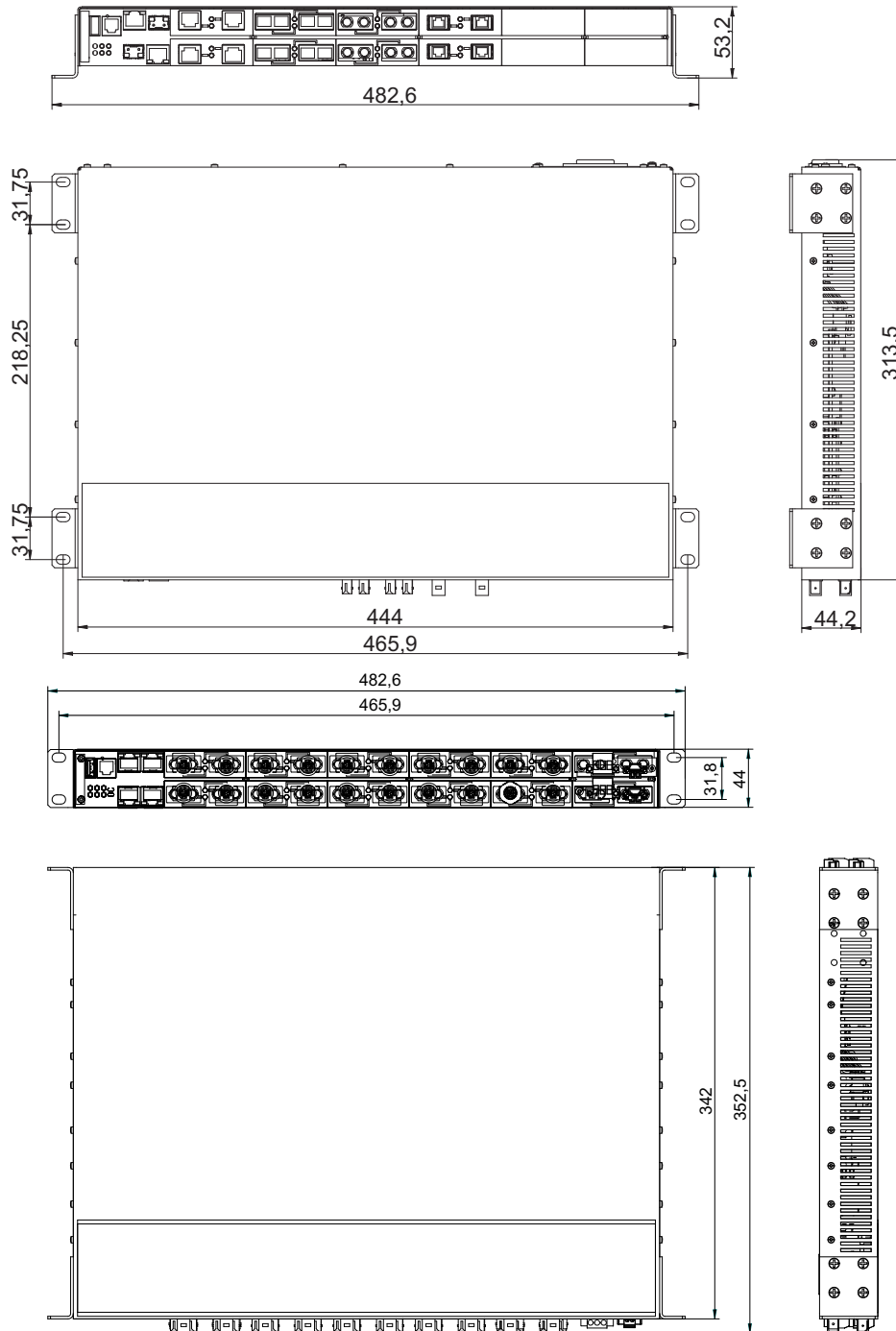

Figure 21: MACH1000, dimensions of the device variants

■ EMC and immunity

EMC interference immunity IEC/EN 61850-3 EMI TYPE test, test according to	Description	Test level
IEC/EN 61000-4-2	Electrostatic discharge	
	Contact discharge	±8 kV
	Air discharge	±15 kV
IEC/EN 61000-4-3	Electromagnetic field	
	80 MHz ... 2700 MHz	20 V/m
IEC/EN 61000-4-4	Fast transients (burst)	
	DC Power Line	±4 kV
	AC Power Line	±4 kV
	Data line	±4 kV
IEC/EN 61000-4-5	Voltage surges	
	DC Power Line	±2 kV line/ground; ±1 kV line/line
	AC Power Line	±4 kV line/ground; ±2 kV line/line
	Data line	±4 kV line/ground
IEC/EN 61000-4-6	Conducted disturbances	
	150 kHz ... 80 MHz	10 V
IEC/EN 61000-4-12	Damped oscillation	
	DC Power Line	±2,5 kV line/earth; ±1 kV line/line
	AC Power Line	±2,5 kV line/earth; ±1 kV line/line
	Data line	±2,5 kV line/earth; ±1 kV line/line
IEC 60255-5	dielectric strength	
	DC Power Line power supply unit characteristic value C, L	500 V AC
	AC Power Line power supply unit characteristic value G, M	2000 V AC
	DC Power Line power supply unit characteristic value G, M	2000 V AC
	Signal contact characteristic value C, L, G, M	2000 V AC

EMC interference immunity IEEE 1613 EMI TYPE test, test according to	Description	Test level
IEEE C37.90.3	Electrostatic discharge	
	Contact discharge	±8 kV
	Air discharge	±15 kV
IEEE C37.90.2	Electromagnetic field	
	80 MHz ... 1000 MHz	35 V/m (peak)
IEEE C37.90.1	Fast transients (burst)	
	DC Power Line	±4 kV
	AC Power Line	±4 kV
	Data line	±4 kV

EMC interference immunity IEEE 1613 EMI TYPE test, test according to	Description	Test level
IEEE C37.90.1	Damped oscillation	
	DC Power Line	±2,5 kV line/earth; ±1 kV line/line
	AC Power Line	±2,5 kV line/earth; ±1 kV line/line
	Data line	±2,5 kV line/earth; ±1 kV line/line
IEEE C37.90	H.V. Impulse	
	DC Power Line	± 5 kV line/earth
	AC Power Line	± 5 kV line/earth
IEEE C37.90	dielectric strength	
	DC Power Line power supply unit characteristic value C, L	500 V AC
	AC Power Line power supply unit characteristic value G, M	2000 V AC
	DC Power Line power supply unit characteristic value G, M	2000 V AC
	Signal contact characteristic value C, L, G, M	2000 V AC

EMC interference emission

EN 55032	Class A
FCC 47 CFR Part 15	Class A
German Lloyd	Classification + Construction Guidelines VI-7-3 Part 1 Ed. 2001

Environment TYPE test, test according to	Description	Test level
IEC 60068-2-1	Cold	-40 °F (-40 °C), 16 hours
IEC 60068-2-2	Dry heat	+185 °F (+85 °C), 16 hours
IEC 60068-2-30	Relative humidity	95 % (non condensing) 131 °F (55 °C), 4 cycles
IEC 60068-2-6	Vibration, test Fc	2 - 9 Hz with 3 mm amplitude 1 g at 9 - 150 Hz 1.5 g at 200 - 500 Hz
IEC 60068-2-27	Shock, test Ea	15 g at 11 ms

■ Network range

Note: The line lengths specified for the transceivers apply for the respective fiber data (fiber attenuation and Bandwidth Length Product (BLP)/ Dispersion).

Product code M-SFP-...	Mode	Wave length	Fiber	System attenuation	Example for F/O cable length ^a	Fiber attenuation	BLP ^b /Dispersion
-SX/LC...	MM	850 nm	50/125 μm	0 dB ... 7.5 dB	0 km ... 0.55 km (0 mi ... 0.34 mi)	3.0 dB/km	400 MHz×km
-SX/LC...	MM	850 nm	62.5/125 μm	0 dB ... 7.5 dB	0 km ... 0.275 km (0 mi ... 0.17 mi)	3.2 dB/km	200 MHz×km
-MX/LC...	MM	1310 nm	50/125 μm	0 dB ... 12 dB	0 km ... 1.5 km (0 mi ... 0.93 mi)	1.0 dB/km	800 MHz×km
-MX/LC...	MM	1310 nm	62,5/125 μm	0 dB ... 12 dB	0 km ... 0.50 km (0 mi ... 0.31 mi)	1,0 dB/km	500 MHz×km
-LX/LC...	MM	1310 nm ^c	50/125 μm	0 dB ... 10.5 dB	0 km ... 0.55 km (0 mi ... 0.34 mi)	1.0 dB/km	800 MHz×km
-LX/LC...	MM	1310 nm ^d	62.5/125 μm	0 dB ... 10.5 dB	0 km ... 0.55 km (0 mi ... 0.34 mi)	1.0 dB/km	500 MHz×km
-LX/LC...	SM	1310 nm	9/125 μm	0 dB ... 10.5 dB	0 km ... 20 km (0 mi ... 12.43 mi) ^e	0.4 dB/km	3.5 ps/(nm×km)
-LX+/LC...	SM	1310 nm	9/125 μm	5 dB ... 20 dB	14 km ... 42 km (8.70 mi ... 26.10 mi)	0.4 dB/km	3.5 ps/(nm×km)
-LH/LC...	LH	1550 nm	9/125 μm	5 dB ... 22 dB	23 km ... 80 km (14.29 mi ... 49.71 mi)	0.25 dB/km	19 ps/(nm×km)
-LH+/LC	LH	1550 nm	9/125 μm	15 dB ... 30 dB	71 km ... 108 km (44.12 mi ... 67.11 mi)	0.25 dB/km	19 ps/(nm×km)
-LH+/LC	LH	1550 nm	9/125 μm	15 dB ... 30 dB	71 km ... 128 km (44.12 mi ... 79.54 mi)	0.21 dB/ km (typically)	19 ps/(nm×km)

Table 9: F/O port 1000BASE-FX (SFP fiber optic Gigabit Ethernet Transceiver)

- a. Including 3 dB system reserve when compliance with the fiber data is observed.
 b. Using the bandwidth-length product is inappropriate for expansion calculations.

- c. With F/O adapter compliant with IEEE 802.3-2002 Clause 38 (single-mode fiber offset-launch mode conditioning patch cord).
- d. With F/O adapter compliant with IEEE 802.3-2002 Clause 38 (single-mode fiber offset-launch mode conditioning patch cord).
- e. Including 2.5 dB system reserve when compliance with the fiber data is observed.

Product code M-SFP-BIDI...	Mode	Wave length TX	Wave length RX	Fiber	System attenuation	Example for F/O cable length ^a	Fiber attenuation	Dispersion
Type A LX/LC EEC SM	SM	1310 nm	1550 nm	9/125 µm	0 dB ... 11 dB	0 km ... 20 km (0 mi ... 12.43 mi)	0.4 dB/km	3.5 ps/(nm×km)
Type B LX/LC EEC SM	SM	1550 nm	1310 nm	9/125 µm	0 dB ... 11 dB	0 km ... 20 km (0 mi ... 12.43 mi)	0.25 dB/km	19 ps/(nm×km)
Type A LH/LC EEC LH	LH	1490 nm	1590 nm	9/125 µm	5 dB ... 24 dB	23 km ... 80 km (14.29 mi ... 49.71 mi)	0.25 dB/km	19 ps/(nm×km)
Type B LH/LC EEC LH	LH	1590 nm	1490 nm	9/125 µm	5 dB ... 24 dB	23 km ... 80 km (14.29 mi ... 49.71 mi)	0.25 dB/km	19 ps/(nm×km)

Table 10: F/O port (bidirectional Gigabit Ethernet SFP transceiver)

- a. Including 3 dB system reserve when compliance with the fiber data is observed.

Product code	Mode ^a	Wave length	Fiber	System attenuation	Example for F/O line length ^b	Fiber attenuation	BLP/Dispersion
M-FAST-SFP-MM/LC...	MM	1310 nm	50/125 µm	0 dB ... 8 dB	0 km ... 5 km (0 mi ... 3.11 mi)	1.0 dB/km	800 MHz×km
M-FAST-SFP-MM/LC...	MM	1310 nm	62.5/125 µm	0 dB ... 11 dB	0 km ... 4 km (0 mi ... 2.49 mi)	1.0 dB/km	500 MHz×km
M-FAST-SFP-SM/LC...	SM	1310 nm	9/125 µm	0 dB ... 13 dB	0 km ... 25 km (0 mi ... 15.53 mi)	0.4 dB/km	3.5 ps/(nm×km)
M-FAST-SFP-SM+/LC...	SM	1310 nm	9/125 µm	10 dB ... 29 dB	25 km ... 65 km (15.53 mi ... 40.39 mi)	0.4 dB/km	3.5 ps/(nm×km)
M-FAST-SFP-LH/LC...	SM	1550 nm	9/125 µm	10 dB ... 29 dB	47 km ... 104 km (29.20 mi ... 64.62 mi)	0.25 dB/km	19 ps/(nm×km)

Table 11: F/O port 100BASE-FX (SFP Fiber Optic Fast Ethernet Transceiver)

Product code	Mode ^a	Wave length	Fiber	System attenuation	Example for F/O line length ^b	Fiber attenuation	BLP/Dispersion
M-FAST-SFP-LH/LC...	SM	1550 nm	9/125 μm	10 dB ... 29 dB	55 km ... 140 km (14.29 mi ... 86.99 mi)	0.18 dB/km ^c	18 ps/(nm×km)
SFP-FAST-MM/LC ^d	MM	1310 nm	50/125 μm	0 dB ... 8 dB	0 km ... 5 km (0 mi ... 3.11 mi)	1.0 dB/km	800 MHz×km
SFP-FAST-MM/LC EEC ^d	MM	1310 nm	62.5/125 μm	0 dB ... 11 dB	0 km ... 4 km (0 mi ... 2.49 mi)	1.0 dB/km	500 MHz×km
SFP-FAST-SM/LC ^d	SM	1310 nm	9/125 μm	0 dB ... 13 dB	0 km ... 25 km (0 mi ... 15.53 mi)	0.4 dB/km	3.5 ps/(nm×km)
SFP-FAST-SM/LC EEC ^d	SM	1310 nm	9/125 μm	0 dB ... 13 dB	0 km ... 25 km (0 mi ... 15.53 mi)	0.4 dB/km	3.5 ps/(nm×km)

Table 11: F/O port 100BASE-FX (SFP Fiber Optic Fast Ethernet Transceiver)

- a. MM = Multimode, SM = Singlemode, LH = Singlemode Longhaul
b. Including 3 dB system reserve when compliance with the fiber data is observed.
c. With ultra-low-loss optical fiber.
d. You will find further information on certifications on the Internet on the Hirschmann product pages (www.hirschmann.com).

Product code	Mode	Wave length	Fiber	System attenuation	Example for F/O cable length ^a	Fiber attenuation	BLP/Dispersion
-FF	MM	820 nm	50/125 μm	0 dB ... 9.5 dB	0 km ... 2.1 km (0 mi ... 1.31 mi)	3.0 dB/km	400 MHz×km
-FF	MM	820 nm	62.5/125 μm	0 dB ... 12.5 dB	0 km ... 3 km (0 mi ... 1.86 mi)	3.2 dB/km	200 MHz×km

Table 12: F/O port 10BASE-FL

- a. Including 3 dB system reserve when compliance with the fiber data is observed.

Product code	Mode	Wave length	Fiber	System attenuation	Example for F/O cable length ^a	Fiber attenuation	BLP/Dispersion
-JJ, -MM, -NN, -BB	MM	1300 nm	50/125 μm	0 dB ... 8 dB	0 km ... 5 km (0 mi ... 3.11 mi)	1.0 dB/km	800 MHz×km
-JJ, -MM, -NN, -BB	MM	1300 nm	62.5/125 μm	0 dB ... 11 dB	0 km ... 4 km (0 mi ... 2.49 mi)	1.0 dB/km	500 MHz×km
-VV, -UU	SM	1300 nm	9/125 μm	0 dB ... 16 dB	0 km ... 30 km (0 mi ... 18.64 mi)	0.4 dB/km	3.5 ps/(nm×km)
-LL	LH	1550 nm	9/125 μm	3 dB ... 29 dB	14 km ... 104 km (8.70 mi ... 64.62 mi)	0.25 dB/km;	19 ps/(nm×km)
-GG	LH	1550 nm	9/125 μm	14 dB ... 47 dB	67 km ... 176 km (41.63 mi ... 109.36 mi)	0.25 dB/km	19 ps/(nm×km)

Table 13: F/O port 100BASE-FX (DSC/DST fiber optic Fast Ethernet Transceiver)

a. Including 3 dB system reserve when compliance with the fiber data is observed.

MM = Multimode, SM = Singlemode, LH = Singlemode Longhaul

10/100/1000 Mbit/s twisted pair port	
Length of a twisted pair segment	max. 100 m (328 ft) (for Cat5e cable)

Table 14: Network range: 10/100/1000 Mbit/s twisted pair port

■ Power consumption/power output

Name	Max. power consumption	Max. power output
Basic devices		
MAR1020-... basic device (without Fast Ethernet module)	7.5 W	25.6 Btu (IT)/h
MAR1030-... basic device (incl. 2 × Gigabit Ethernet module combo ports, without Fast Ethernet module)	10.5 W	35.9 Btu (IT)/h
MAR1x3y-4O... Basic device (x = 0 or 1, y = 0 or 2)	11.5 W	39.2 Btu (IT)/h
MAR1x3y-4T... Basic device (x = 0 or 1, y = 0 or 2)	14.5 W	49.5 Btu (IT)/h
MAR1x3y-OT... Basic device (x = 0 or 1, y = 0 or 2)	13.0 W	44.4 Btu (IT)/h
Fast Ethernet module		
additionally per Fast Ethernet FX module	2.0 W	6.9 Btu (IT)/h
additionally per Fast Ethernet TX module	0.4 W	1.4 Btu (IT)/h
additionally per PoE module	38.0 W	130.0 Btu (IT)/h
Examples		
MAR1020-99TTTTTTTTTTTTTTTTTTTTTTTTTTTTTTTTTUG9HPHHXX.X	12.3 W	42.0 Btu (IT)/h
MAR1020-99TTTTTTTTTTTTTTMMMMMMMMMMMMMMMMMUG9HPHHXX.X	21.9 W	74.8 Btu (IT)/h
MAR1020-99MMMMMMMMMMMMMMMMMMMMMMMMMMMMMMMMMUG9HPHHXX.X	31.5 W	107.5 Btu (IT)/h
MAR1030-CCTTTTTTTTTTTTTTTTTTTTTTTTTTTTTTTTTTUG9HPHHXX.X	15.3 W	52.2 Btu (IT)/h
MAR1030-CCTTTTTTTTTTTTTTTMMMMMMMMMMMMMMMMMUG9HPHHXX.X	24.9 W	85.0 Btu (IT)/h
MAR1030-CCMMMMMMMMMMMMMMMMMMMMMMMMMMMMMMMMMUG9HPHHXX.X	34.5 W	117.8 Btu (IT)/h
MAR1030-4TMMMMMMMMMMMMMMMMMMMMMMMMMMMMMMMMMUG9HPHHXX.X	38.5 W	131.4 Btu (IT)/h
MAR1032-4TTTRMMMMMMMMMMMMMMMMMMMMMMMMMMMMMMMMMUGGHPHHXX.X, no PD (powered device)	35.3 W	120.5 Btu (IT)/h
MAR1132-4OTTRMMMMMMMMMMMMMMMMMMMMMMMMMMMMMMMM9999UGGHPHHXX.X, no PD (powered device)	28.3 W	96.6 Btu (IT)/h
MAR1032-4TTTRMMMMMMMMMMMMMMMMMMMMMMMMMMMMMMMMMUGGHPHHXX.X, 4 x Class-0 PD (powered device)	111.3 W	380.5 Btu (IT)/h
MAR1132-4OTTRMMMMMMMMMMMMMMMMMMMMMMMMMMMMMMMM9999UGGHPHHXX.X, 4 x Class-0 PD (powered device)	104.3 W	356.6 Btu (IT)/h

■ Order numbers/product description

Combination options and device names (see table 1).

■ Scope of delivery

Amount	Scope of delivery
1 ×	Device
1 ×	Safety and general information sheet

■ Accessories

Gigabit Ethernet SFP transceiver	Order number
M-SFP-SX/LC	943 014-001
M-SFP-SX/LC EEC	943 896-001
M-SFP-MX/LC	942 035-001
M-SFP-LX/LC	943 015-001
M-SFP-LX/LC EEC	943 897-001
M-SFP-LX+/LC	942 023-001
M-SFP-LX+/LC EEC	942 024-001
M-SFP-LH/LC	943 042-001
M-SFP-LH/LC EEC	943 898-001
M-SFP-LH+/LC	943 049-001

Bidirectional Gigabit Ethernet SFP transceiver	Order number
M-SFP-BIDI Type A LX/LC EEC	943 974-001
M-SFP-BIDI Type B LX/LC EEC	943 974-002
M-SFP-BIDI Type A LH/LC EEC	943 975-001
M-SFP-BIDI Type B LH/LC EEC	943 975-002
M-SFP-BIDI Bundle LX/LC EEC (Type A + B)	943 974-101
M-SFP-BIDI Bundle LH/LC EEC (Type A + B)	943 975-101

Table 15: Accessory: Bidirectional Gigabit Ethernet SFP transceiver

Fast Ethernet SFP transceiver	Order number
M-FAST SFP-TX/RJ45	942 098-001
M-FAST SFP-TX/RJ45 EEC	942 098-002

The following operating conditions apply to twisted pair transceivers:

- ▶ Usable with:
 - HiOS as of software version 03.0.00
 - for PRP ports on RSP devices, as of software version 02.0.01
 - for PRP ports on EES devices, as of software version 02.0.02
 - Classic switch software as of software version 08.0.00
 - HiSecOS as of software version 01.2.00
- ▶ Longer RSTP switching times and link loss detection times compared to twisted pair ports provided by the device directly.
- ▶ Not applicable for combo ports.
- ▶ Not applicable for ports which support only Gigabit Ethernet.
- ▶ It is currently not possible to set autocrossing manually.

M-FAST SFP-MM/LC	943 865-001
------------------	-------------

Table 16: Accessory: Fast Ethernet SFP transceiver

Fast Ethernet SFP transceiver	Order number
M-FAST SFP-MM/LC EEC	943 945-001
M-FAST SFP-SM/LC	943 866-001
M-FAST SFP-SM/LC EEC	943 946-001
M-FAST SFP-SM+/LC	943 867-001
M-FAST SFP-SM+/LC EEC	943 947-001
M-FAST SFP-LH/LC	943 868-001
M-FAST SFP-LH/LC EEC	943 948-001
SFP-FAST-MM/LC ^a	942 194-001
SFP-FAST-MM/LC EEC ^a	942 194-002
SFP-FAST-SM/LC ^a	942 195-001
SFP-FAST-SM/LC EEC ^a	942 195-002

Table 16: Accessory: Fast Ethernet SFP transceiver

- a. You will find further information on certifications on the Internet on the Hirschmann product pages (www.hirschmann.com).

Other accessories	Order number
AutoConfiguration Adapter ACA22-USB (EEC)	942 124-001
Terminal cable	943 301-001
3-pin High Voltage Interlock terminal block (50 pcs.)	943 845-008
3-pin Low Voltage Interlock terminal block (50 pcs.)	943 845-011
Bracket for fastening the housing	943 943-001
Protection cap for RJ45 socket (50 pieces)	943 936-001
Protection cap for SFP slot (25 pieces)	943 942-001
Network management software Industrial HiVision	943 156-xxx

■ Underlying technical standards

Name	
EN 61000-6-2	Electromagnetic compatibility (EMC) – Part 6-2: Generic standards – Immunity for industrial environments
EN 55032	Electromagnetic compatibility of multimedia equipment – Emission Requirements
IEC/EN 62368-1	Equipment for audio/video, information and communication technology - Part 1: safety requirements
EN 61131-2	Programmable controllers – Part 2: Equipment requirements and tests
EN 50121-4	Railway applications - EMC - emitted interference and interference immunity for signal and telecommunication systems
EN 50155	Railway applications – Electronic equipment used on rolling stock
FCC 47 CFR Part 15	Code of Federal Regulations
DNV-CG-0339	Environmental test specification for electrical, electronic and programmable equipment and systems.
UL 508	Safety for Industrial Control Equipment
EN 61850-3	Communications networks and systems in stations
IEEE 1613	Standard Environment and Testing Requirements for Communication Networking Devices in Electric Power Substations
ANSI/ ISA 12.12.01	Nonincendive Electrical Equipment for Use in Class I and II, Division 2, and Class III, Divisions 1 and 2 Hazardous (Classified)Locations

Table 17: List of the technical standards

IEEE 802.1 D	Switching, GARP, GMRP, Spanning Tree
	Media access control (MAC) bridges (includes IEEE 802.1p Priority and Dynamic Multicast Filtering, GARP, GMRP)
IEEE 802.1 Q	Tagging
	Virtual Bridged Local Area Networks (VLAN Tagging, GVRP)
IEEE 802.1 w	Rapid Reconfiguration
IEEE 802.3	Ethernet

Table 18: List of IEEE standards

The device has an approval based on a specific standard exclusively if the approval indicator appears on the device casing.

If your device has a shipping approval according to DNV, you find the approval mark printed on the device label. You will find out whether your device has other shipping approvals on the Hirschmann website at www.hirschmann.com in the product information.

A Further support

Technical questions

For technical questions, please contact any Hirschmann dealer in your area or Hirschmann directly.

You find the addresses of our partners on the Internet at <http://www.hirschmann.com>.

A list of local telephone numbers and email addresses for technical support directly from Hirschmann is available at <https://hirschmann-support.belden.com>.

This site also includes a free of charge knowledge base and a software download section.

Customer Innovation Center

The Customer Innovation Center is ahead of its competitors on three counts with its complete range of innovative services:

- ▶ Consulting incorporates comprehensive technical advice, from system evaluation through network planning to project planning.
- ▶ Training offers you an introduction to the basics, product briefing and user training with certification.
You find the training courses on technology and products currently available at <https://www.belden.com/solutions/customer-innovation-center>.
- ▶ Support ranges from the first installation through the standby service to maintenance concepts.

With the Customer Innovation Center, you decide against making any compromises in any case. Our client-customized package leaves you free to choose the service components you want to use.

Internet:

<https://www.belden.com/solutions/customer-innovation-center>



HIRSCHMANN

A **BELDEN** BRAND